

INSTALLATION INSTRUCTIONS

FUCHS MHL 350 SCRAPHANDLER

NEW CAB OVER SERIAL # 367



1-800-267-2665

1-888-267-3745 (FAX)

EVAPORATOR COIL: The evaporator assembly mounts into the existing heater/filter/pressurizer setup that is located under the operators seat. It is accessed from under the cab by removing the metal cover panel.

1. Raise the cab up about 2' to allow easier access to the bottom of the cab.
2. Remove the cab entrance step and two metal cover panels from the bottom of the cab.
3. If the heater has been plumbed in, clamp off the heater lines just behind the cab. Remove the heater/lines from the heater coil. The electronic heater control valve can remain in place on the heater coil. Move the heater lines out of the heater box area temporarily.
4. Cut away tie wraps and temporarily move away hydraulic lines that block access to the metal panel, directly behind the heater coil, in the floor of the cab.



Flex ducts
removed

Heater hoses
removed

Metal panel
removed

5. Disconnect and move temporarily the electrical wiring harness going to the heater control valve if it is present (newer machines)
6. Remove the four philps screws holding the metal panel, (behind the heater coil) in place and remove it from the machine.
7. Replace the metal panel with the evaporator coil assembly supplied in the kit. Slide the assembly up into place so that the fittings are located on the left side of the cab. (same side as the heater coil outlets)

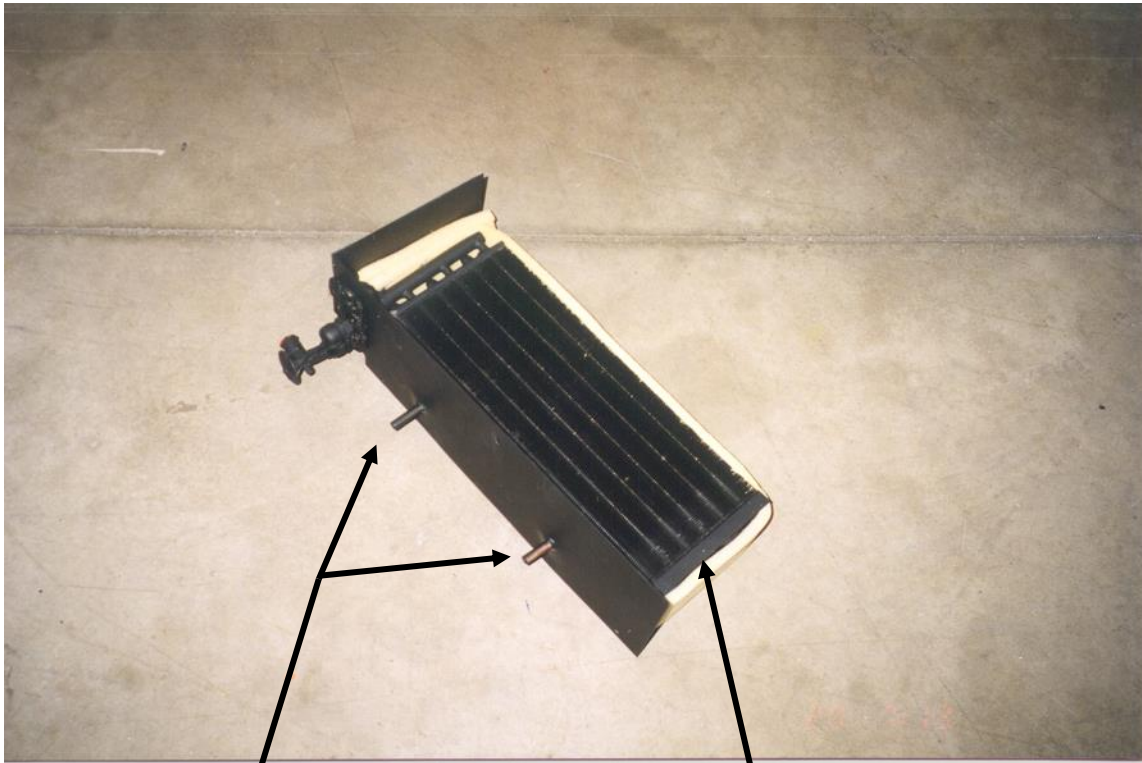

Drain tubes

Evaporator coil
assembled to access
panel

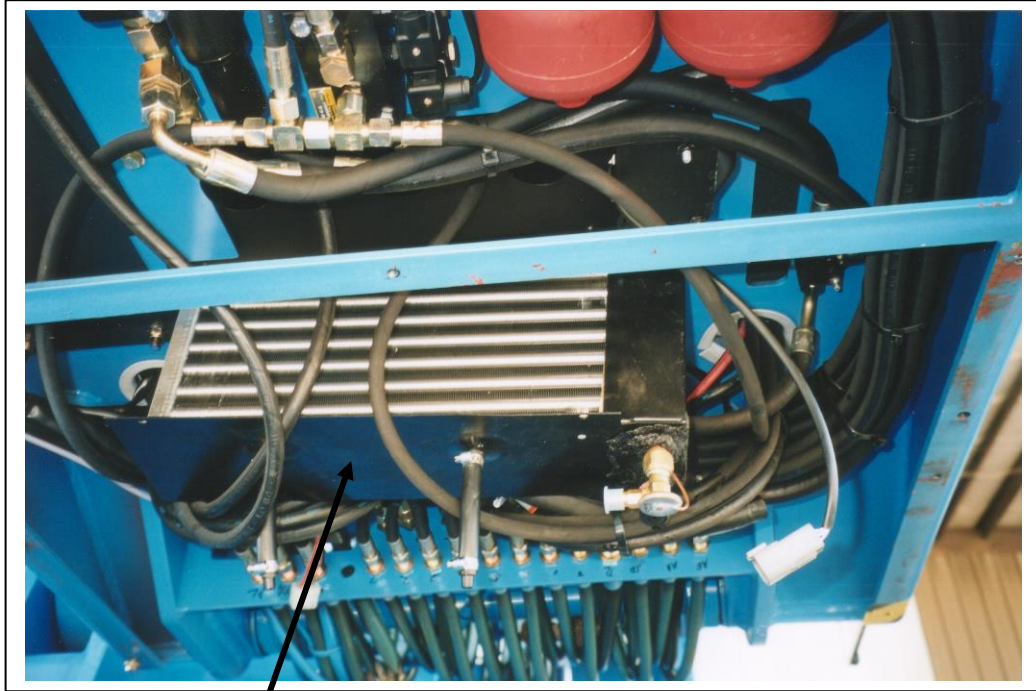

Evaporator coil
assembly sliding into
place

8. Secure the evaporator assembly into place by re-using the four philps screws previously removed. Add two more screws to secure the middle section of the evaporator about half way along the front length of the evaporator coil and the second one on the back side of the evaporator coil. Use the self drilling screws supplied in the kit. This will limit any bowing and air gaps along the bottom of the evaporator coil assembly. If not already done, install short sections of drain tube and a drain tube restrictor to each drain pipe.

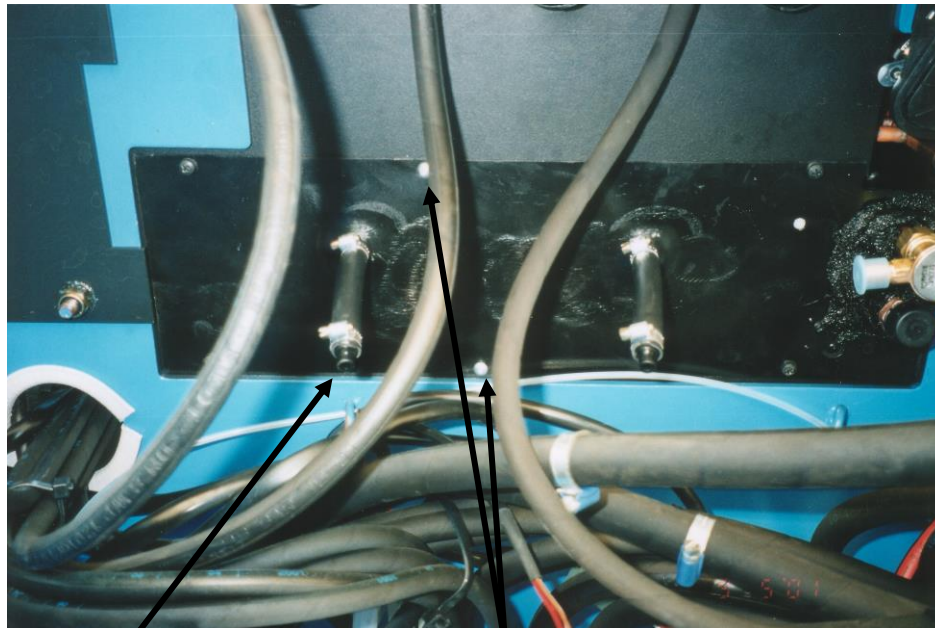

Drain tube and
restrictor

Extra screws

9. Once the thermostat probe has been inserted up into the evaporator coil through the pre-drilled hole in the bottom of the evaporator panel, all holes and gaps around the evaporator and heater coils and outlet pipes can be sealed with tar tape and foam tape to eliminate air loss.

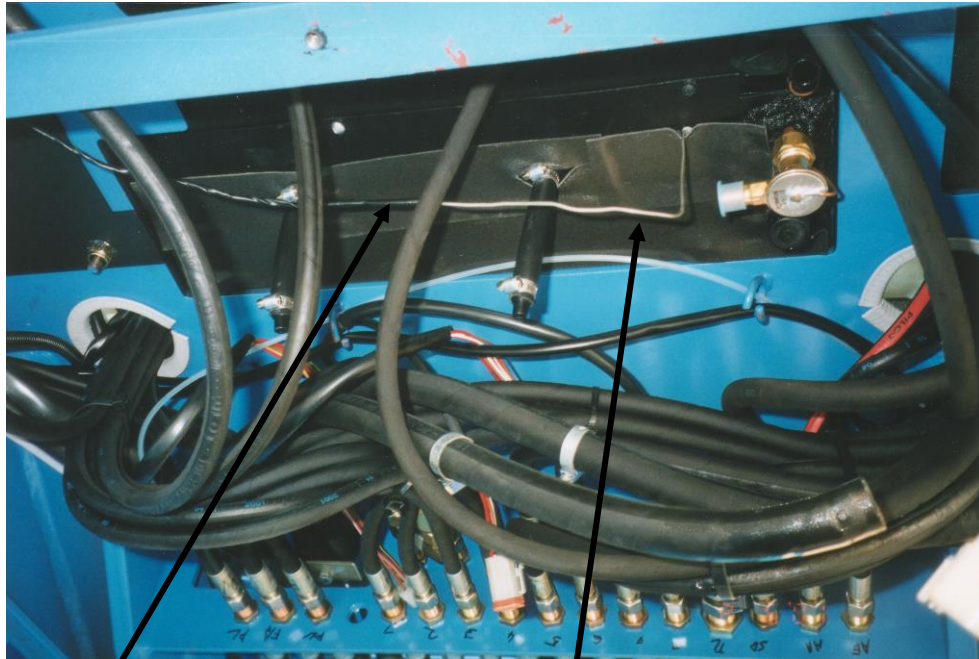

Foam insulation
tape

Thermostat probe
being inserted 5" to 6"
into the coil

10. Put a layer of foam tape insulation on the metal bottom of the heater/A/C box to limit heat transfer from hot air under the floor.

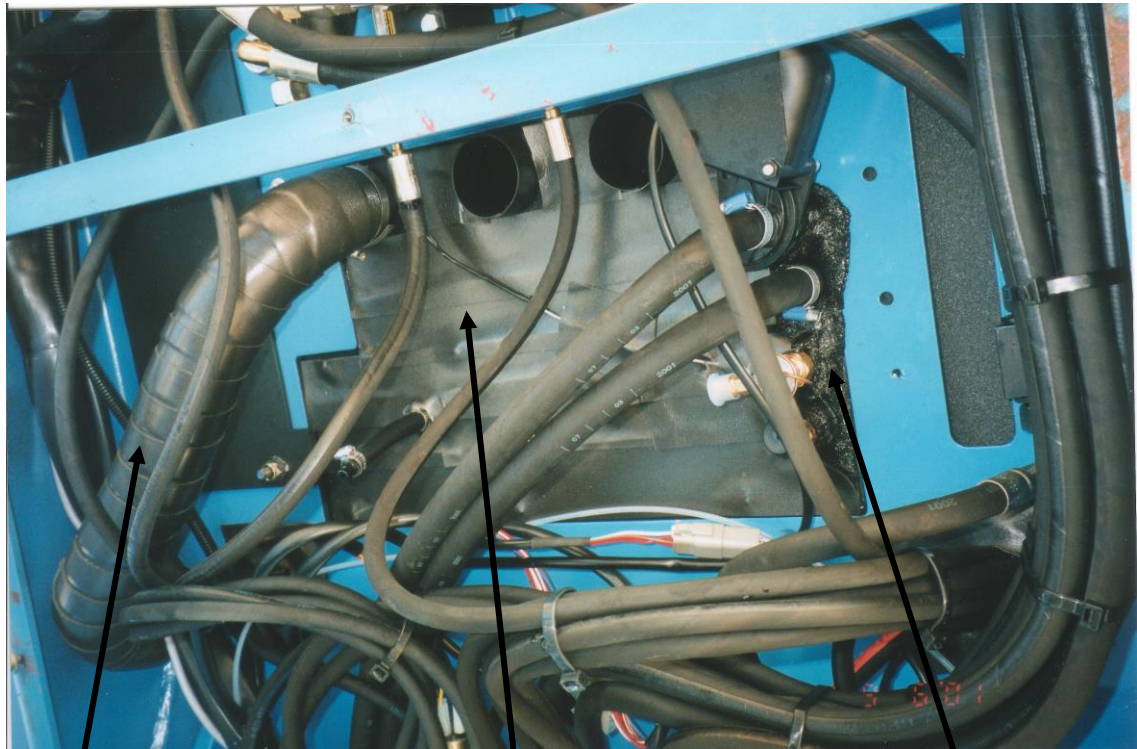

Insulated flex duct

Insulated bottom of box with foam tape

Gaps around heater and A/C lines sealed with tar tape

11. Seal all holes in the floor of the cab as well as possible using foam tape and tar tape to limit the hot air incursion into the cab from the hot hydraulic components mounted below the cab floor. Big areas that can be sealed are: 1) the hydraulic control line holes on either side of the operators seat. 2) The large rectangular hole beneath the front right electrical console in the cab. 3) All other small openings for wires or hoses

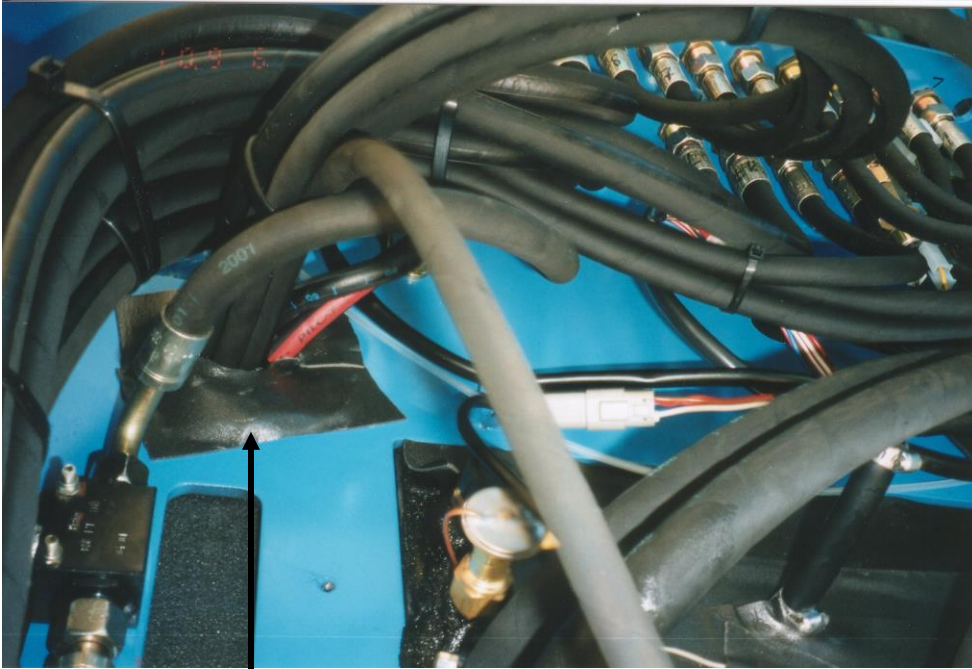

Foam tape around hyd.
Lines entering the cab
floor

12. Remove the three flex ducts that carry air from the heat/A/C box to various louvers around the cab.

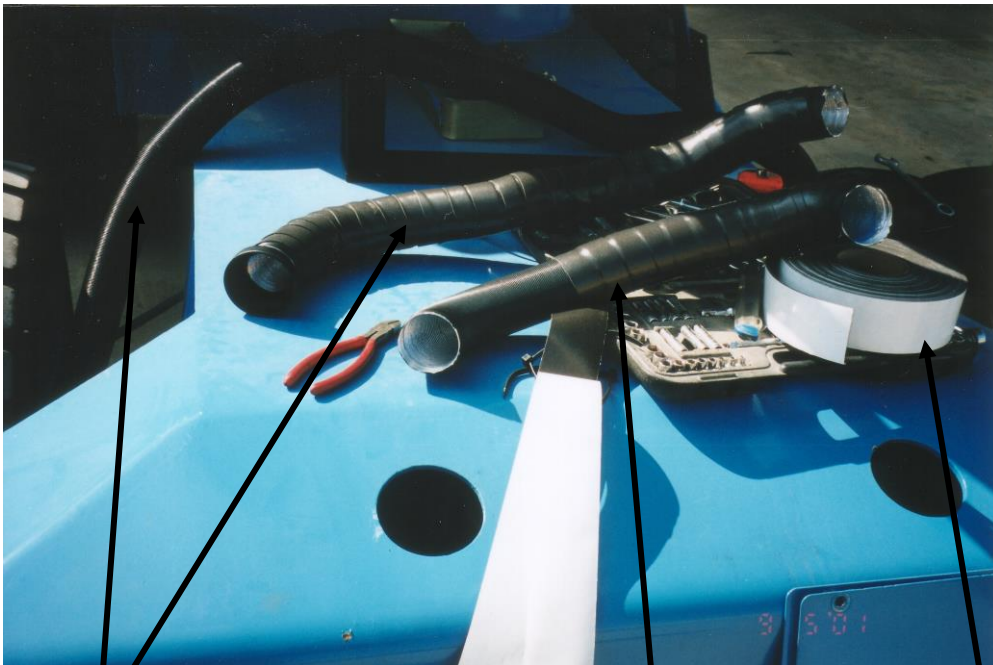

Flex ducts

Spiral wrap pattern

Insulation tape

13. Using the insulation tape supplied in the kit put a double layer of foam insulation on the flex ducts. A spiral overlaying tape pattern works well. Leave two to three inches at each end bare to allow for reclamping of the flex ducts to their outlets. On the first 24" of duct on the largest length that passes up through the front right corner of the cab, only put a single non-overlapping layer of foam to make re-installation easier.
14. Re-attach the three insulated flex ducts back to their original positions.

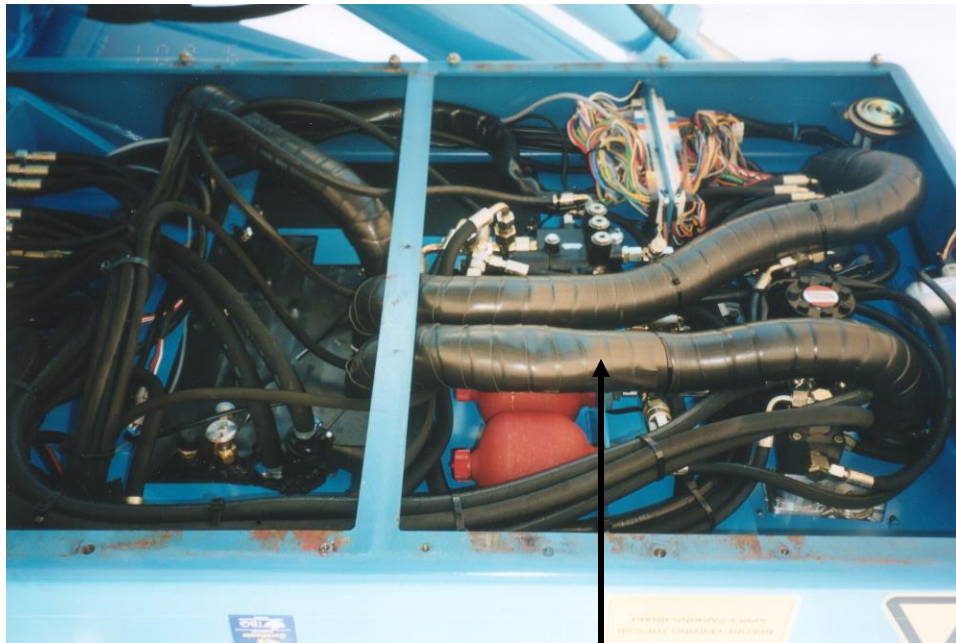

Insulated flex duct
re-installed

15. On older machines that have a diesel fired cab heater there are a number of splices and “Y” connectors on the flex ducts. If this diesel heater is no longer being used. (ie. Replaced with hot water heater) remove the extra duct and “Y” connectors to maximize the cab air flow by reducing the restrictions.
16. From inside the cab, through an access panel behind the seat, the evaporator coil assembly needs to be sealed to the heater/A/C box walls all the way around. This will ensure that all the air flow from the blower assembly passes through the A/C coil.

17. Pull the seat all the way forward to gain access to the panel directly behind the seat and ahead of the inside air intake vents. Remove the seven philips screws from the panel and lift the panel off the heater/A/C box. This same panel also accesses the heater/A/C filter assembly for cleaning and service. Remove the air filter and frame by pulling it straight up.
18. Unbolt the blower assembly frame by removing the four philips screws that secure it. There are two on each vertical surfaces on either side of the heater A/C box. Slide the blower assembly towards the rear of the cab to access the evaporator coil.
19. Using foam, foam tape and or tar tape, seal any air gaps around the sides and top of the evaporator coil and frame.
20. Re-install the blower assembly and filter. ****Note**** If the filter is dirty, remove it from its frame and wash it. Shake it dry and re-install it into the frame and replace the frame behind the blower assembly. Replace the access panel and seven screws.
21. Once all the A/C hoses are connected, all moved components are replaced, the thermostat tested, and the bottom of the heater/A/C box is checked for a air leaks, the two metal panels and the step can be replaced.

Compressor: The compressor is located on the bottom right hand corner of the engine and is driven off a pulley that is added to the alternator drive pulley assembly.

Steps:

- 1) Pulley installation.

Remove the three M8 bolts from the alternator drive pulley located to the left and below the alternator.

Place the add on pulley over the alternator drive pulley. The centering lip around the outer edge of the add on pulley goes against the alternator drive pulley. Rotate the pulley until its mount holes line up with the three holes on the alternator drive pulley.

Use the longer M8 hardware supplied in the compressor mount hardware bag to bolt the alternator pulley in place in front of the alternator pulley. Double check that the centering side of the add on pulley is against the alternator drive pulley.

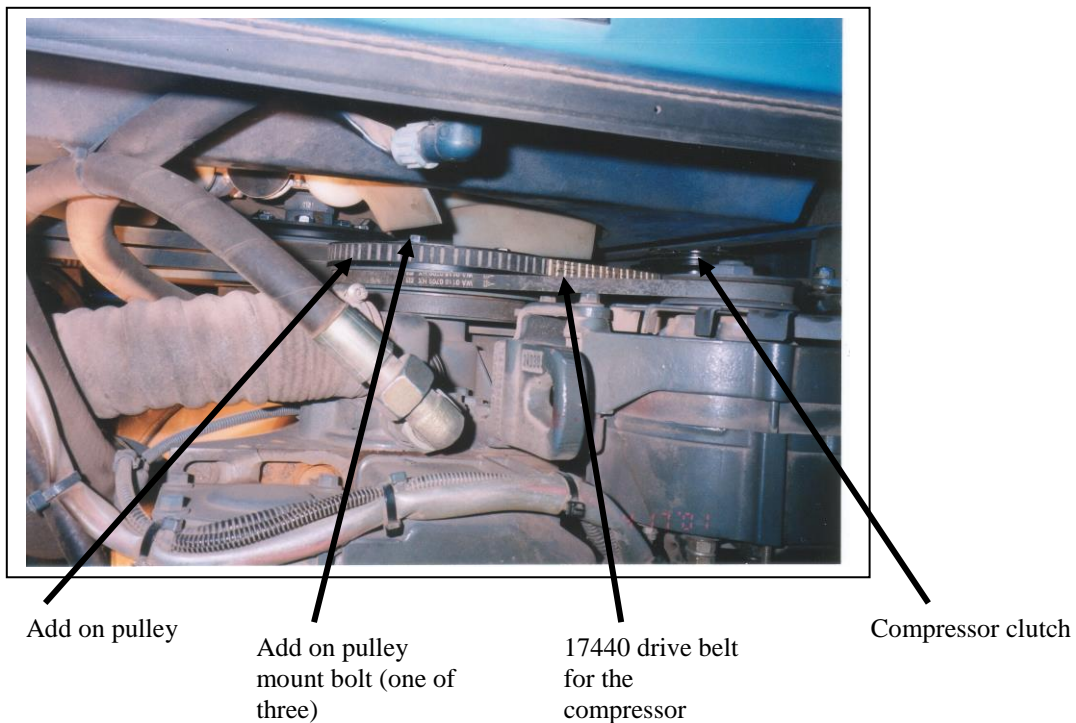

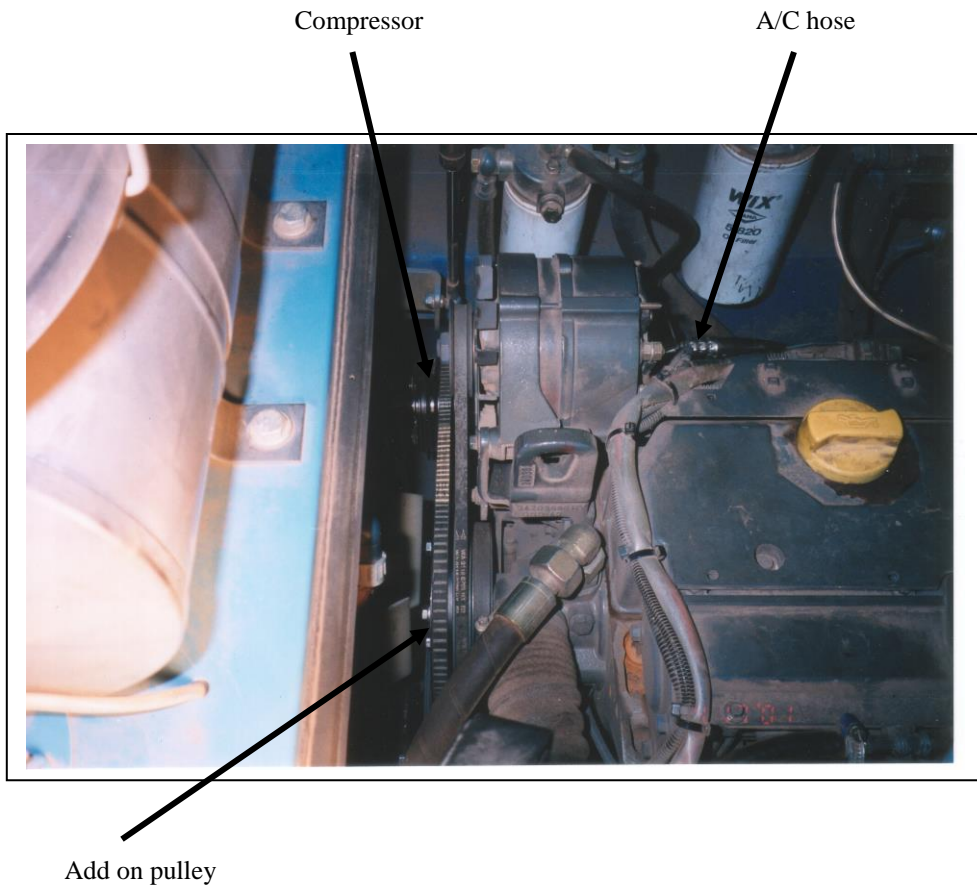

2) Mount installations

The compressor mount bolts to the radiator side of the right front engine amount bracket.

Disconnect the braided steel fuel line from the fuel pump and re-route it to run up the backside of the engine mount.

Reconnect the fuel line to the fuel pump. Ensure that the fuel line is protected from rubbing once the compressor has been mounted.

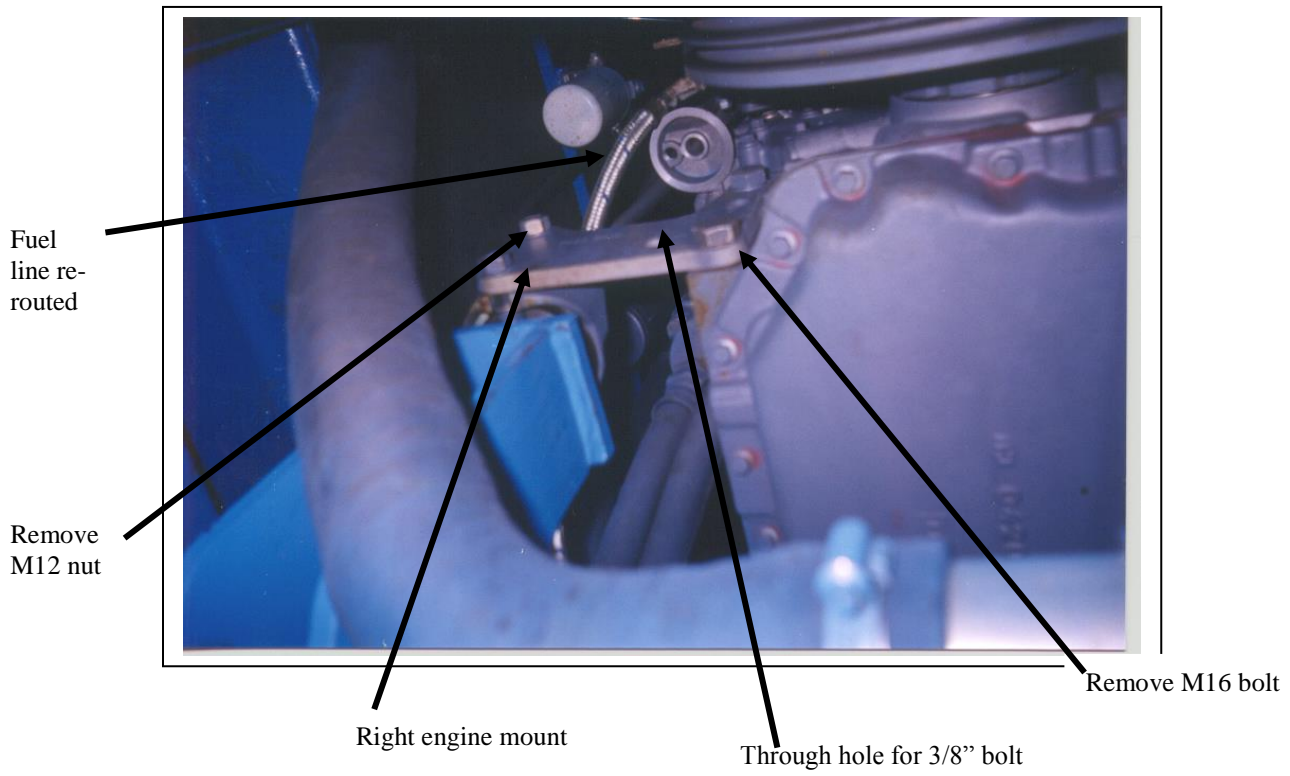

- 3) Remove the M16 bolt from the lower mount hole on the back engine mount bracket. Remove the nut from the upper M12 bolt on the rubber end of the engine mount. Remove the M10 bolts and nuts from the rad hose support brackets on both engine mounts.

Rad hose support bracket bolted back in place with two M10 washers in between as spacers

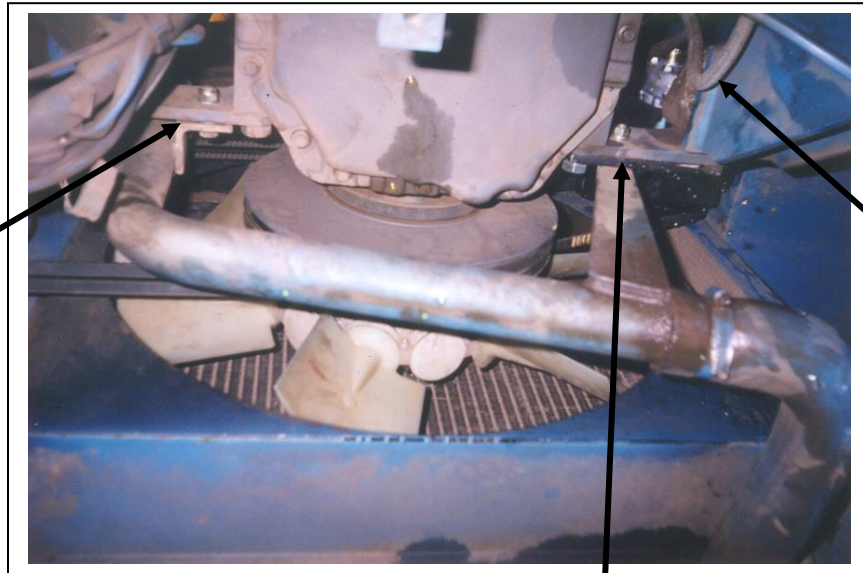

Fuel line re-routed

Rad hose support bracket bolted in place

- 4) Set the mount into place on the fan side of the back (right) engine mount bracket. Thread the upper M12 bolt on the rubber end of the engine mount into the M12 threaded hole on the compressor mount bracket. Use the M16 bolt in the kit to replace the shorter original M16 bolt. Install the M12 x 40mm bolt into the mount hole directly above the lower M16 mount bolt. Bolt the rad hose support bracket back in place overtop of the compressor mount using the M10 x 60mm bolt provided. Bolt the left rad hose support bracket back onto the engine mount using washers as spacers, if required. Use locktight on all mount bolts.

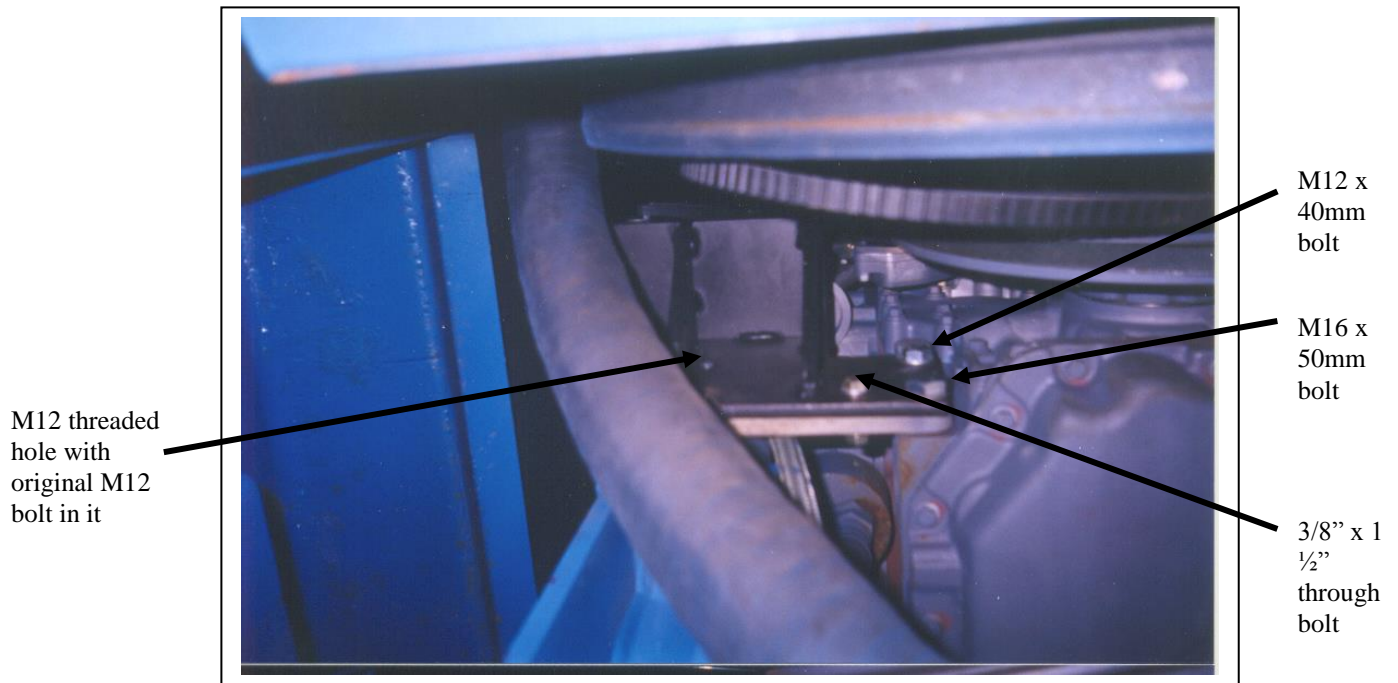

- Place the compressor into the tightener ears and loosely bolt in place using the 3/8" hardware provided. Install the 17440 drive belt around the compressor and add on pulley. Tighten the compressor and secure it in place.

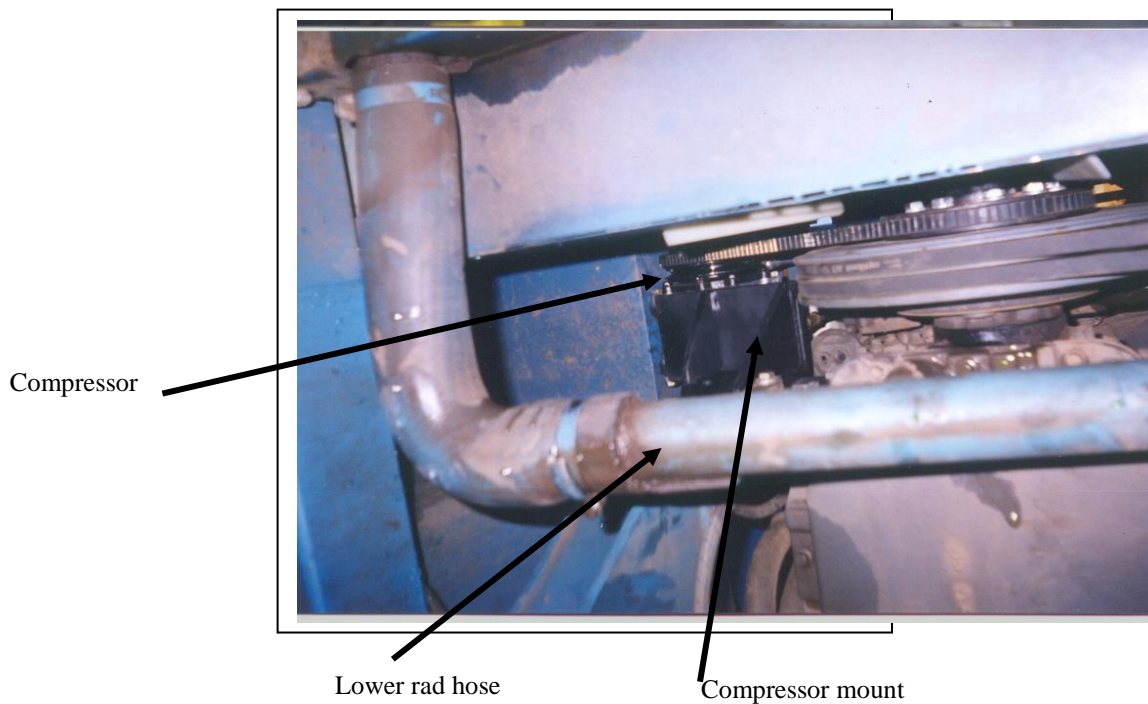

- 6) Install the rotolock fittings provided onto the back of the compressor. Use the white nylon gaskets to seal the rotolocks to the compressor. The gasket is inserted into the groove cut into the end of the fittings on the compressor. Put a few drops of PAG oil onto the nut and flange mating surface of the rotolocks so they don't bind when tightening. Install the 13/32" rotolock onto the discharge fitting on the compressor with the binary pressure switch pointing up. Install the 1/2" rotolock into the suction fitting on the compressor with the 134A access port pointing up.

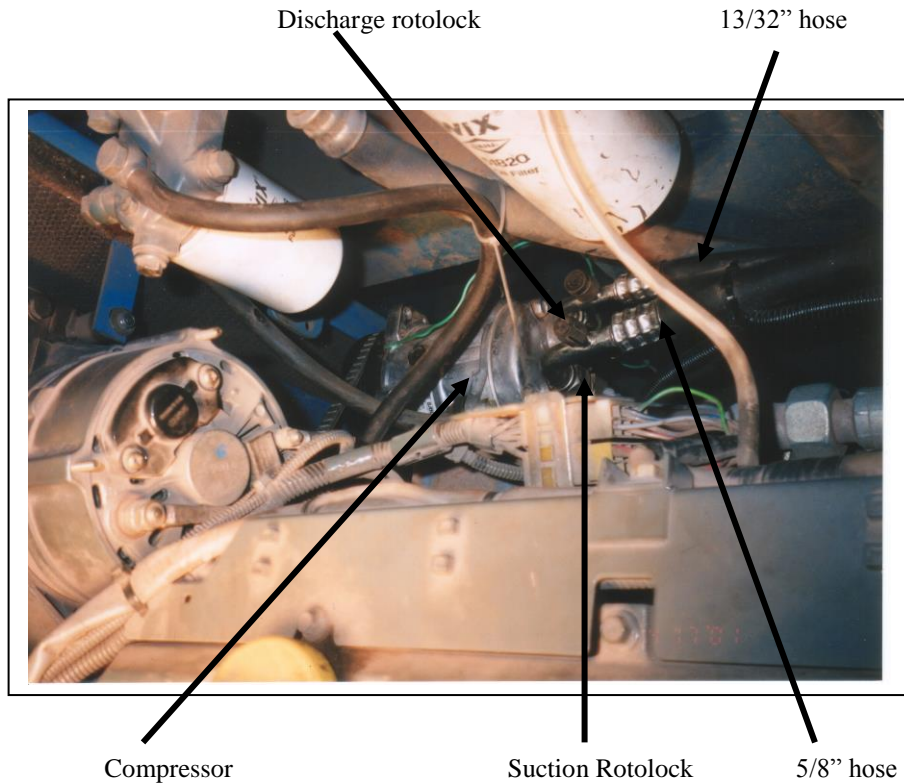

- 7) Hose wrap and secure out of harms way any wire runs, rad hoses and fuel lines that could come into contact with the compressor, belt or mount.

Condenser: The condenser is mounted below the cab hydraulic arm on the left side of the machine, just in behind the removable side panel that is ahead of the hydraulic tank.

Steps:

1. Remove the two cover plates and the side panel from under the cab hydraulic arm. Raise the cab a few feet to better access this area.
2. The two condenser support plates in the kit are designed to be bolted to the existing 1" x 3/4" bars extending out from the "C" channel ahead of the hydraulic tank. Place the support plates onto the bars so that the plates overhang the bracket closest to the hydraulic tank by 1 1/2". Bolt the plates to the bars using 3/8" bolts inserted up through the M12 threaded holes in the bars and going into the 3/8" threaded holes on the support plates. One of the bolt ends sticking up through the support plate may have to be ground flush with the plate so the condenser sits on it flush.

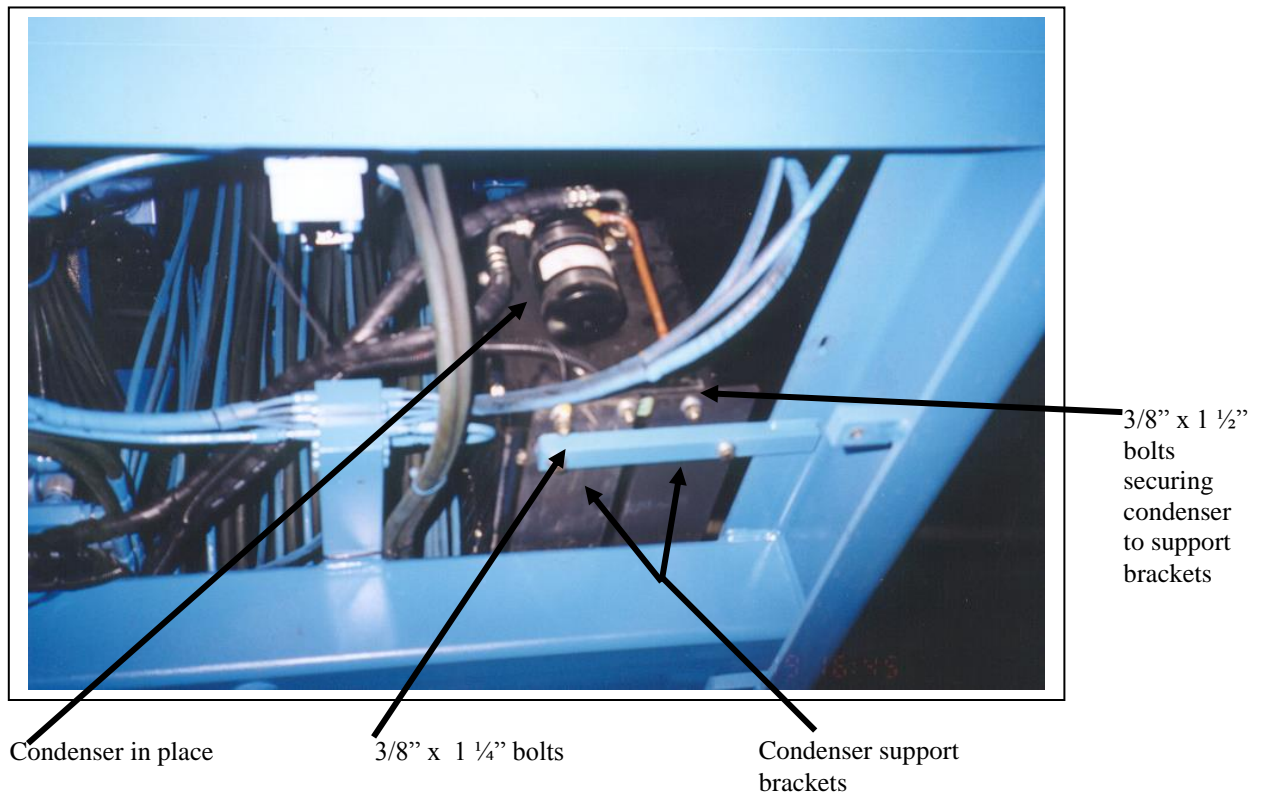

(picture show 360, similar for a 350)

3. Place the heavy duty electric condenser onto the support brackets and bolt in place using the 6, 3/8" x 1 1/2" bolts provided.

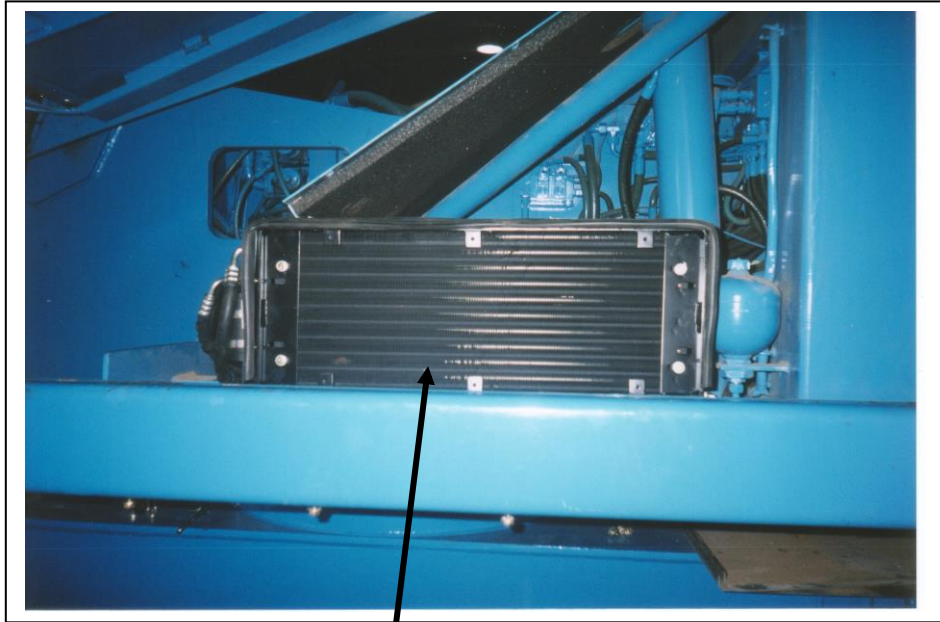

Condenser in place

(picture shows a 340, similar for a 350)

4. Ground the condenser to the machine by crimping a 3/8" yellow ring connector to the black wire coming out of the condenser and bolting the connector to one of the bolts securing the support brackets to the frame, or attach it to a convenient ground lug.

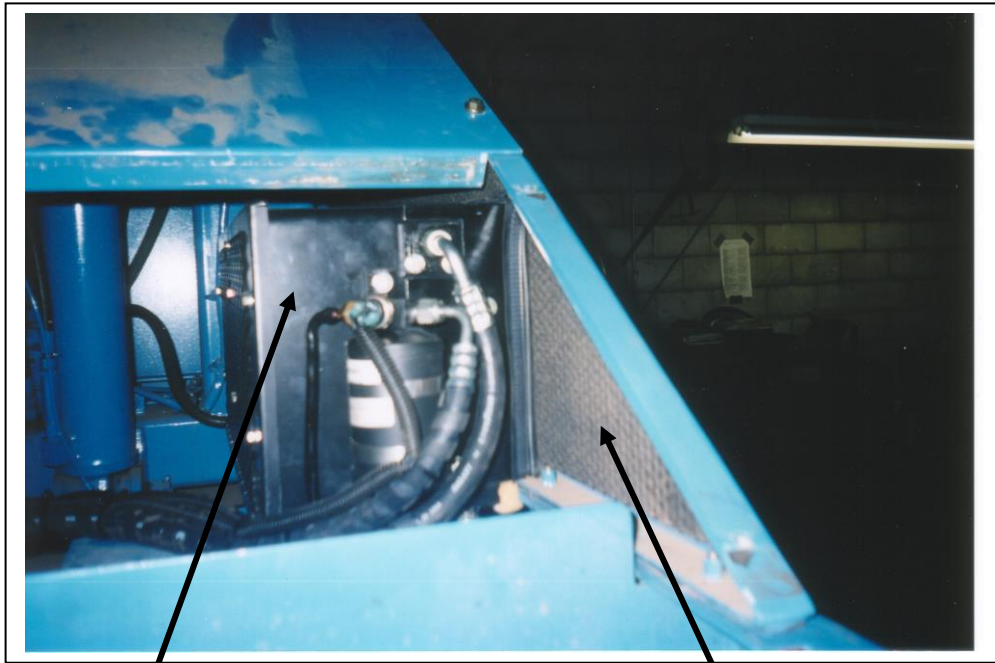

Condenser in place behind
side panel

Side panel in place
without screen installed

(picture shows 340, similar for 350)

5. In all environments it is necessary to cut a hole in the side panel in front of the condenser intake area to allow for improved air flow into the condenser. A 8" high x 22" long hole would be adequate. A piece of 10" x 24" perforated steel has been included in the kit along with 144" of edging and 1/4" mounting hardware.
6. Center the hole for the air intake screen overtop of the Fuchs decal on the side panel. Mark a rectangular cutout 8" high x 22" long. The bottom of the hole should be approx. 1 1/2" up from the bottom of the side panel. Put a double layer of masking tape around the hole to protect the paint.

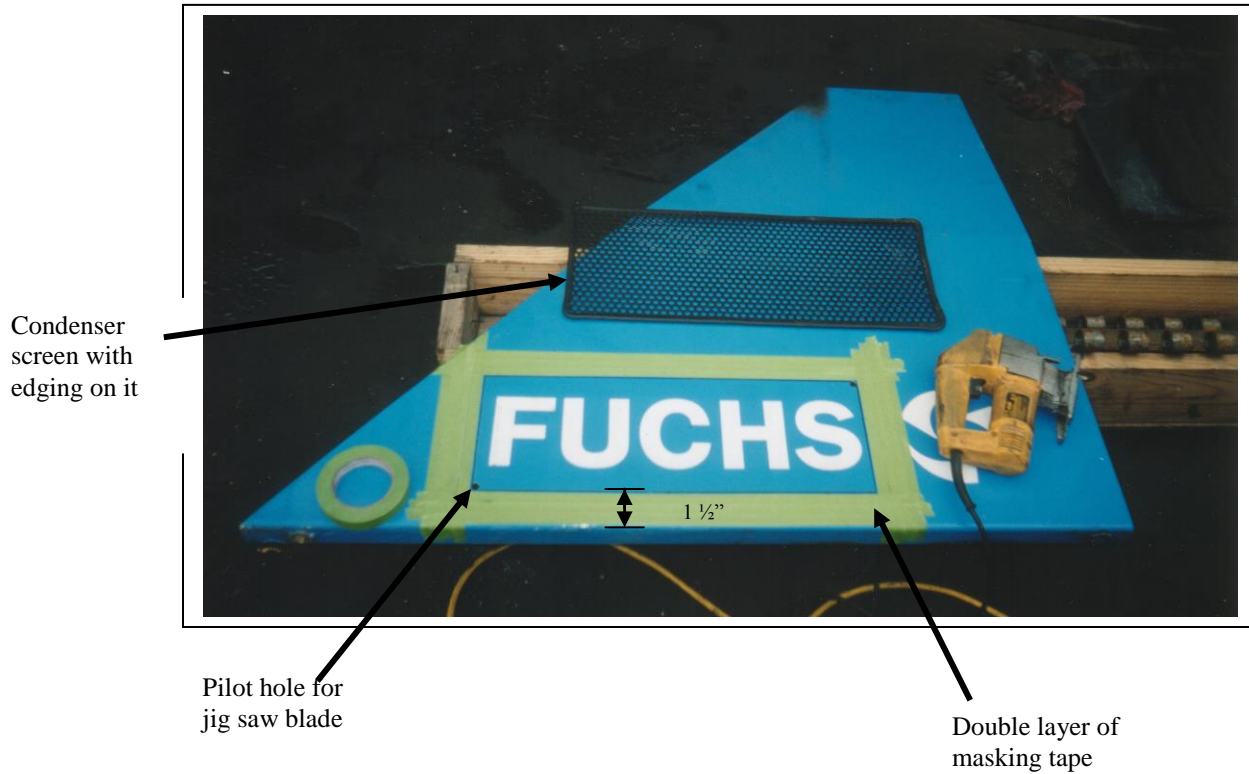

(picture shows 360, similar for 350)

7. Drill a pilot hole in opposite corners of the cut out big enough for a jig saw blade. Use a jig saw to cut out the marked rectangle of steel. Deburr the sharp edges with a hand file.

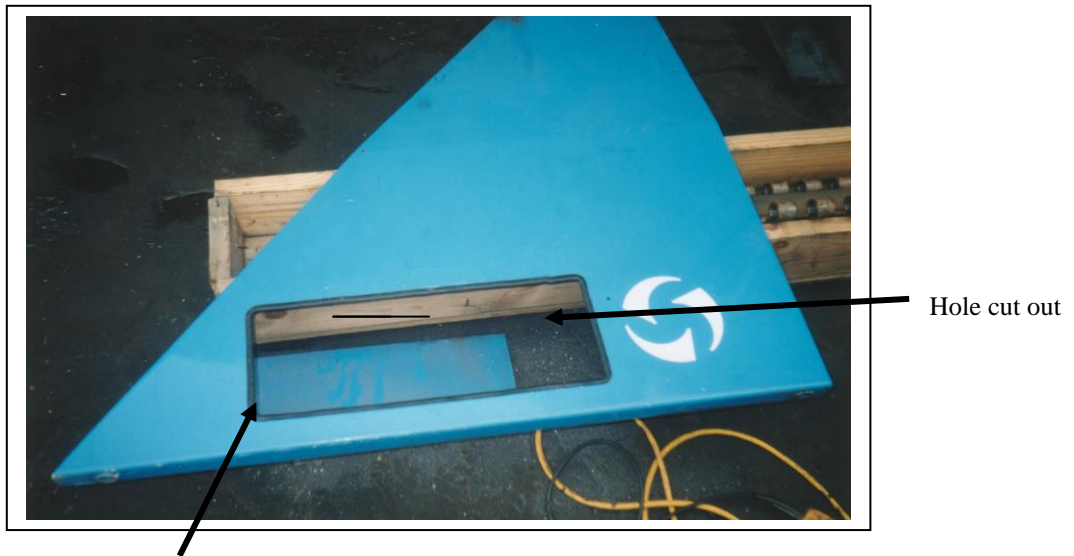

Edging installed on hole

(picture shows 360, similar for 350)

8. Install the black edging all around the cut out. Place the screen overtop the hole and mark six hole to bolt the screen on. Drill the holes for the 1/4" bolts supplied in the kit. Bolt the screen to the inside of the cut out to achieve the cleanest look for the panel. Once the panel is re-installed on the machine, the adjustable shroud on the condenser must be pushed ahead to seal with the inside of the panel. Tighten the securing bolts on the condenser to hold the shroud in place.

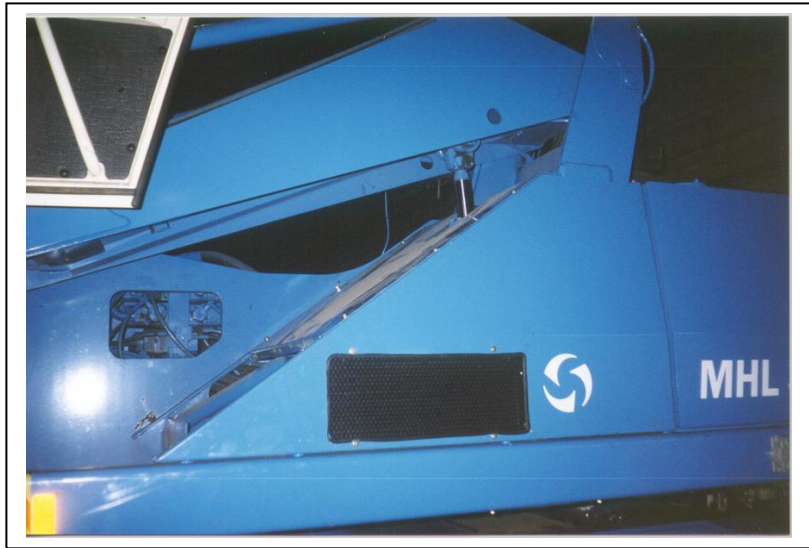

Screen mounted on machine
(picture shows 340, similar for 350)

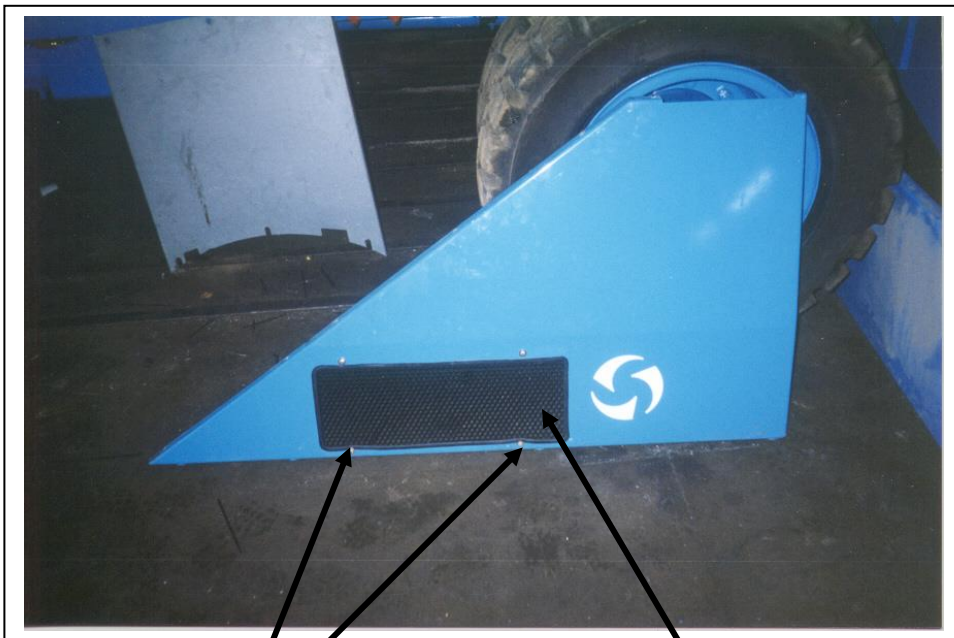

Mounting bolts

Screen mounted to
backside of hole
cutout.

(picture shows 340, similar for 350)

HOSES RUNS:

The hose runs on the MHL 350 are quite long and have to be run carefully to accommodate the telescoping cab design.

Steps:

1. Connect the 90° 5/8" suction line fitting with the low side access port to the suction rotolock on the compressor. This is the rotolock closest to the engine. Connect the 90° 13/32" discharge line fitting with the high side access port to the discharge rotolock on the compressor. This is the rotolock closest to the back of the machine with the binary pressure switch. Use the correct "o rings" and oil all contact surfaces with PAG refrigerant oil.

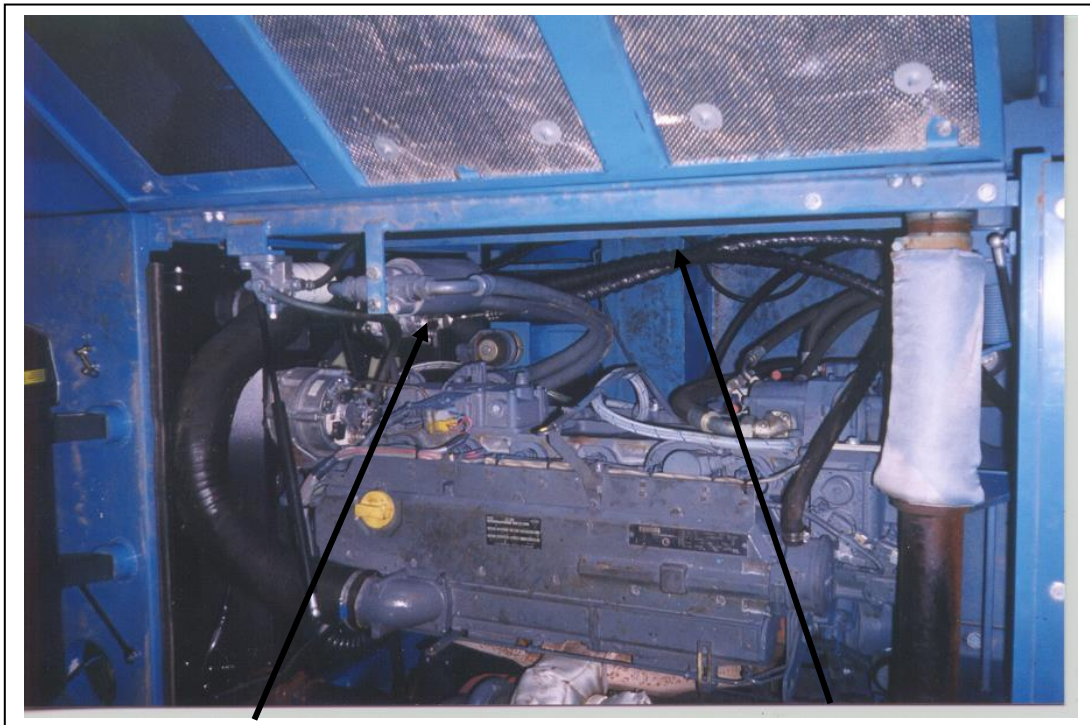

90° 5/8" suction line fitting

13/32" and 5/8" Hoses and wiring running down the right side of the engine

2. Continue the hose run down the back of the engine towards the bottom of the engine compartment. Both hoses run around under the main hydraulic pump. From there the hoses run under all the hydraulic hoses and over to the electric condenser.

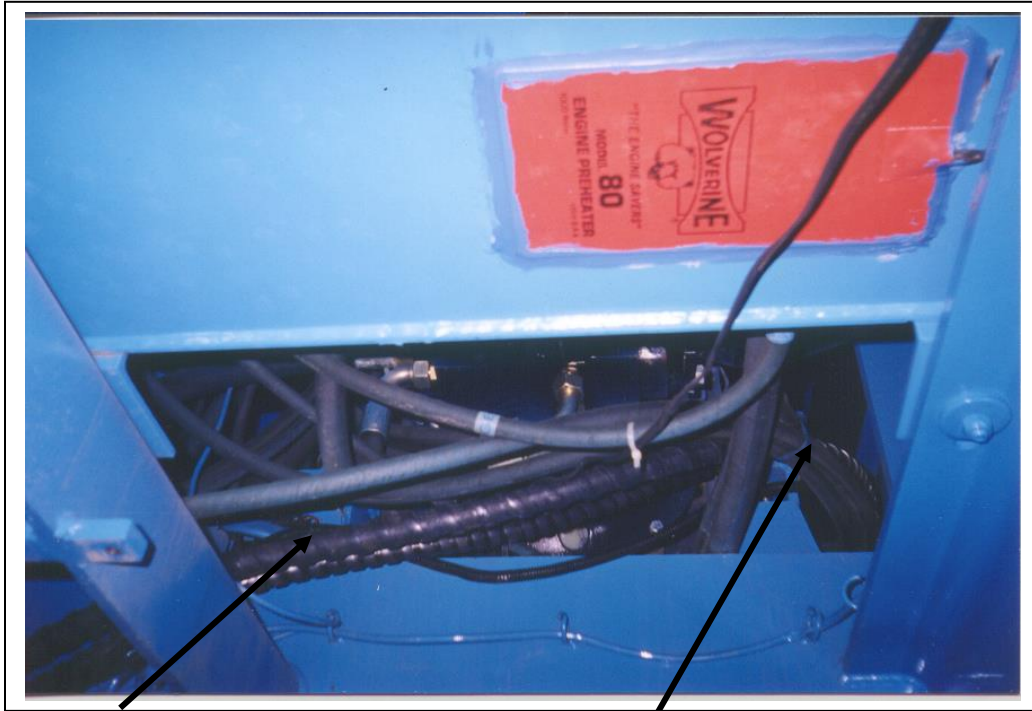

Hoses running under the hydraulic pump towards the electric condenser

Hoses and clutch wire coming out of the engine compartment

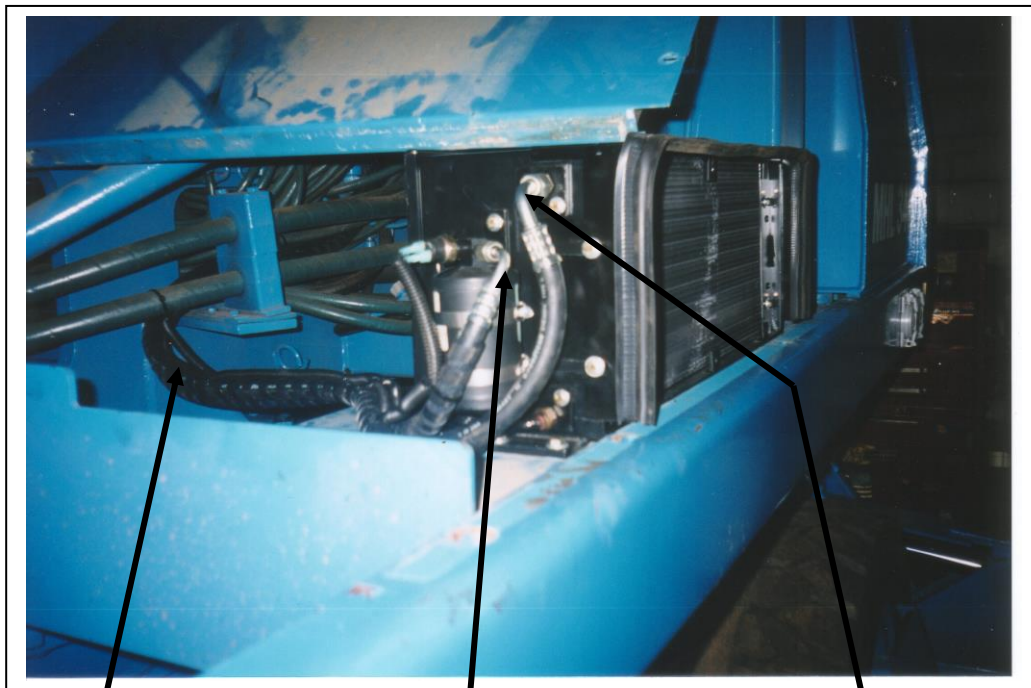

Hoses and wiring continuing towards the electric condenser.

5/16" connection at the drier

13/32" connection

3. Connect the 13/32" hose to the inlet of the electrical condenser. Use the correct "O" ring and oil all contact surfaces.
4. Before reaching the electric condenser the 5/8" suction line splits off from the 13/32" discharge line and follows the electrical harness that runs up to the cabs hydraulic lifting areas.

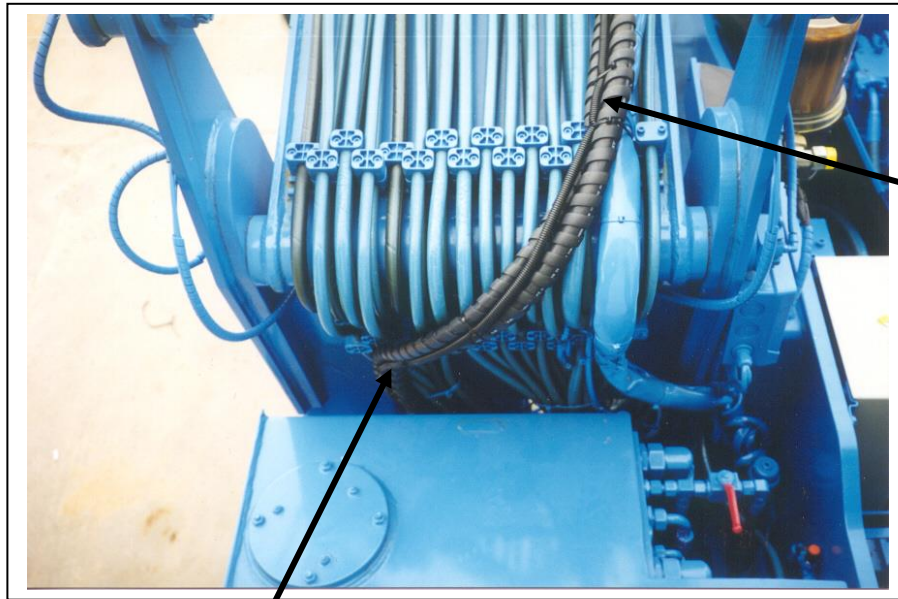

Hoses following wiring harness

Hose and wiring coming up between hydraulic tank and cab arm

5. Connect the 5/16 liquid line up to the outlet fitting on the drier and route it over to the 5/8" suction line. Run both the hoses along the existing wiring harness all the way to the cab. The harness must be followed, so that when the cab is raised and extended the A/C hoses won't be ripped out or pinched. It is a good idea to run the main wire bundle at the same time.

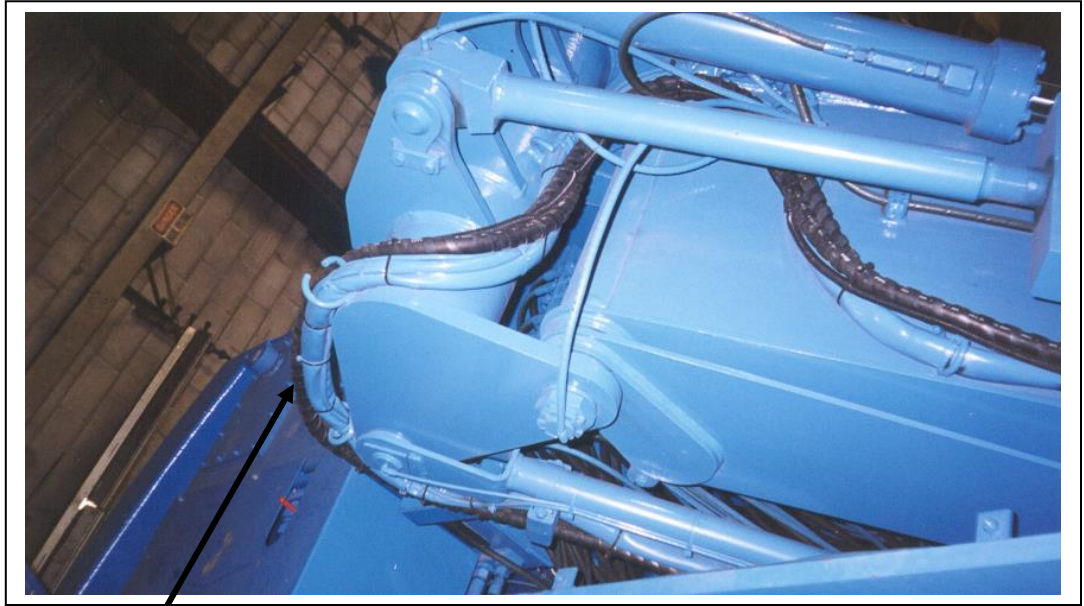

Hoses and wiring following
the factory wire bundle

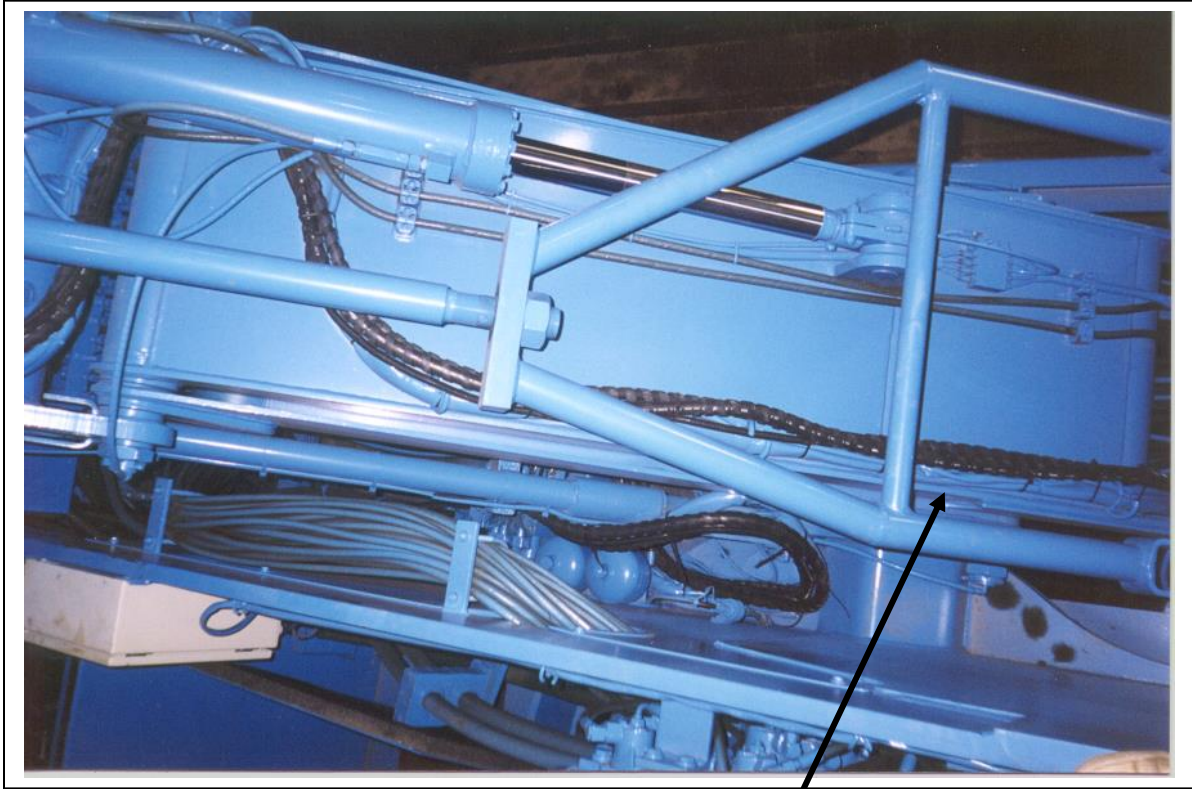

Hoses following factory wire bundle down to the cab.

6. At the back of the cab the hoses run underneath the cab with the other hydraulic hoses and loop around to the fittings at the evaporator. Connect the 5/16" liquid line to the expansion valve. Connect the suction line to the outlet fitting of the evaporator. See pictures in evaporator section. Use the correct "o" rings and oil all contact surfaces.

ELECTRICAL

The electrical system for A/C is activated by the blower switch located on the upper front right control panel in the cab.

Steps:

1. Remove the side panel on the front right control panel to access the blower wiring. Determine which wire coming from the blower switch has 24 volt power whenever the blower switch is turned on any speed. Splice into this wire and run it to the a/c on/off push button switch through a 3 amp inline ATO fuse. The push button switch should be mounted to the right of the ignition key on the same control panel as the blower switch. Drill a 9/16" hole to mount the push button switch into one of the blank rocker switch covers above the heater control knob.

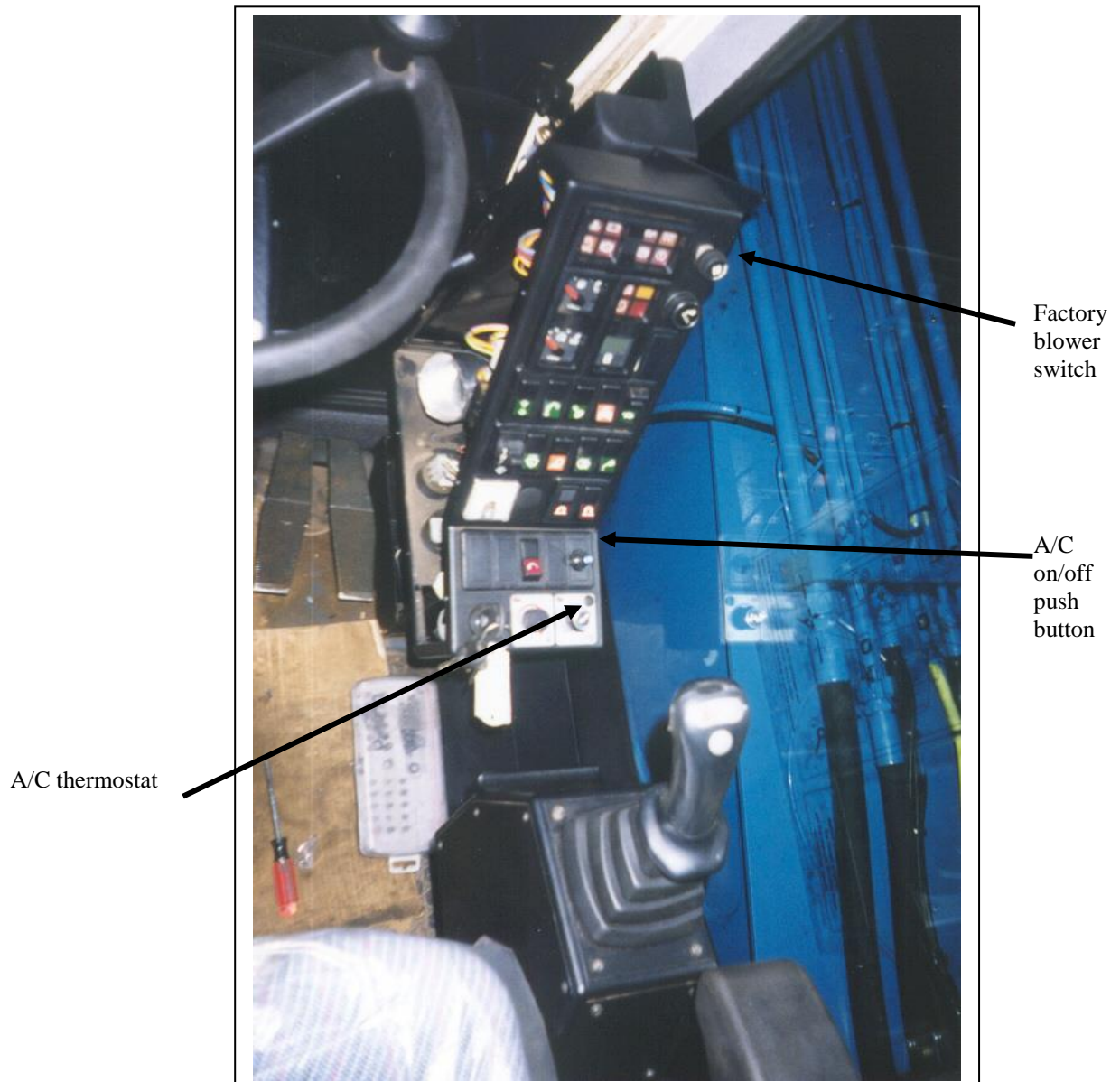

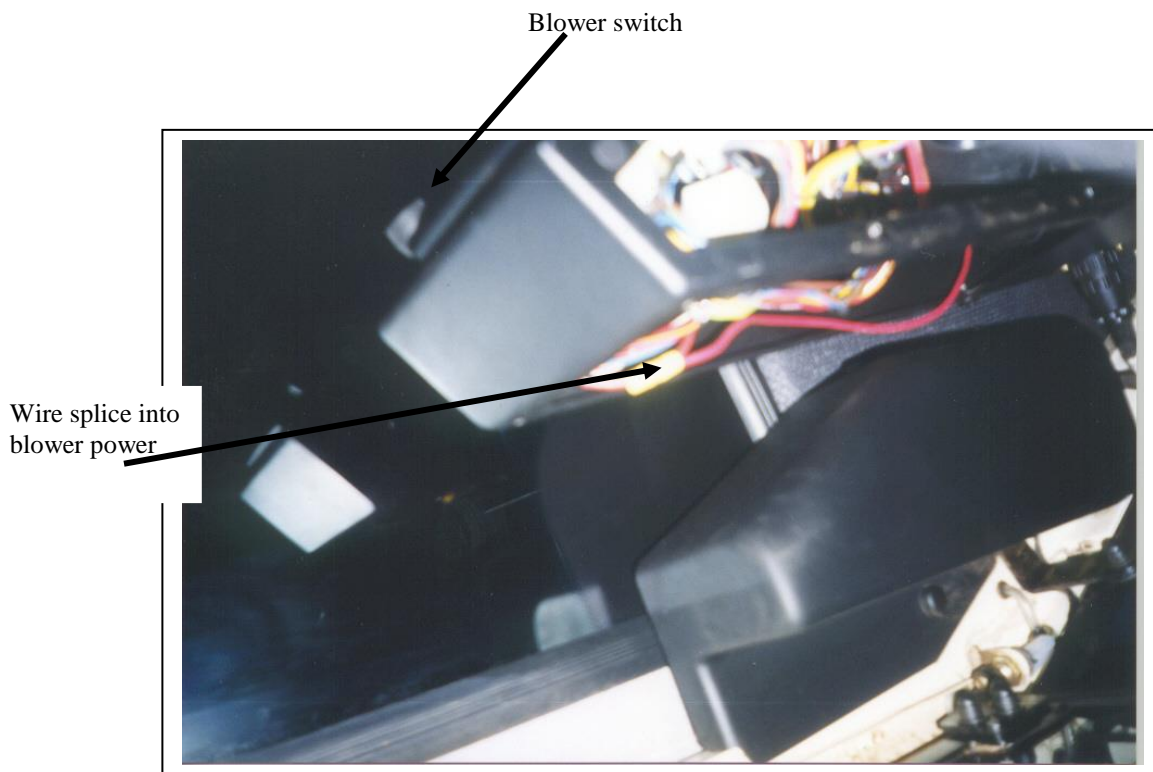

2. The thermostat setup is dash mounted beside the heater control knob. Remove the plug from the thermostat hole. Use a round file to slightly enlarge the thermostat mounting hole until the threaded stem of the thermostat will fit through it. On older machines the hole may not be there at all and a 7/16" hole will have to be drilled. Do not mount the thermostat until the A/C system has been installed and tested. Adjustments may have to be made to the thermostat setting to avoid coil freeze ups.
3. At the second terminal on the A/C on off push button switch, connect the 14 gauge red wire from the three wire electrical bundle. Connect the two black wires to the thermostat terminals. It doesn't matter which black wire goes on which terminal of the thermostat.

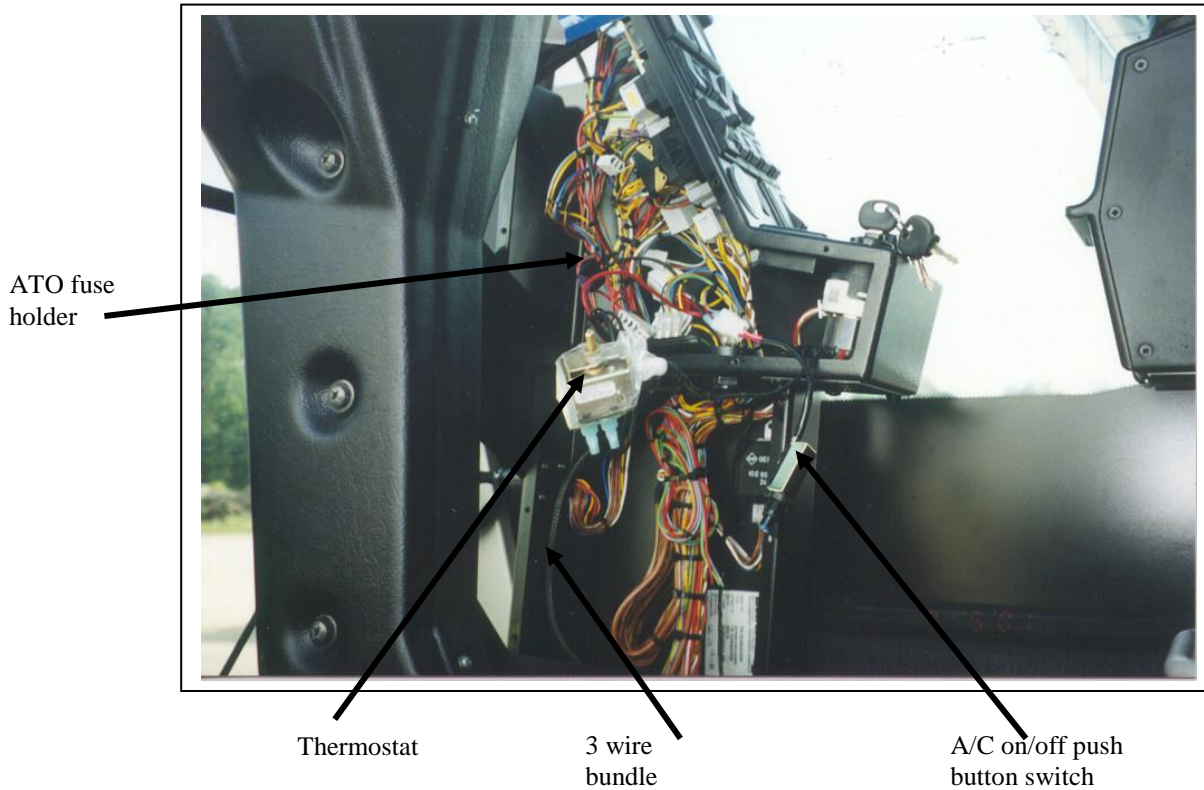

4. Run the 3 wire bundle and the thermostat probe down inside the console and out through the hole in the floor of the cab underneath the console.
5. Route the probe and wire bundle back towards the evaporator coil. Insert the thermostat probe into the evaporator coil as shown in the evaporator installation instructions.

6. Run the three 14 gauge wire in loom along with the A/C hoses out to the engine compartment by following the A/C hoses.
7. Once the wiring gets to the condenser area, have the 12 gauge red wire from the condenser join the wire bundle as it heads towards the engine compartment. If it was not done during installation, ground the 12 gauge black wire from the condenser to a convenient bolt on the frame.
8. Just as the wire bundle enters the engine compartment, split one 14 gauge black wire out of the bundle. This one wire will continue along with the A/C hoses to the binary switch at the compressor. Connect the 14 gauge black wire to one terminal on the binary switch. Connect the clutch wire coming from the compressor to the other terminal on the binary switch.
9. Run the rest of the wire in the bundle over to the power distribution box located on the rear lower left corner of the engine compartment.

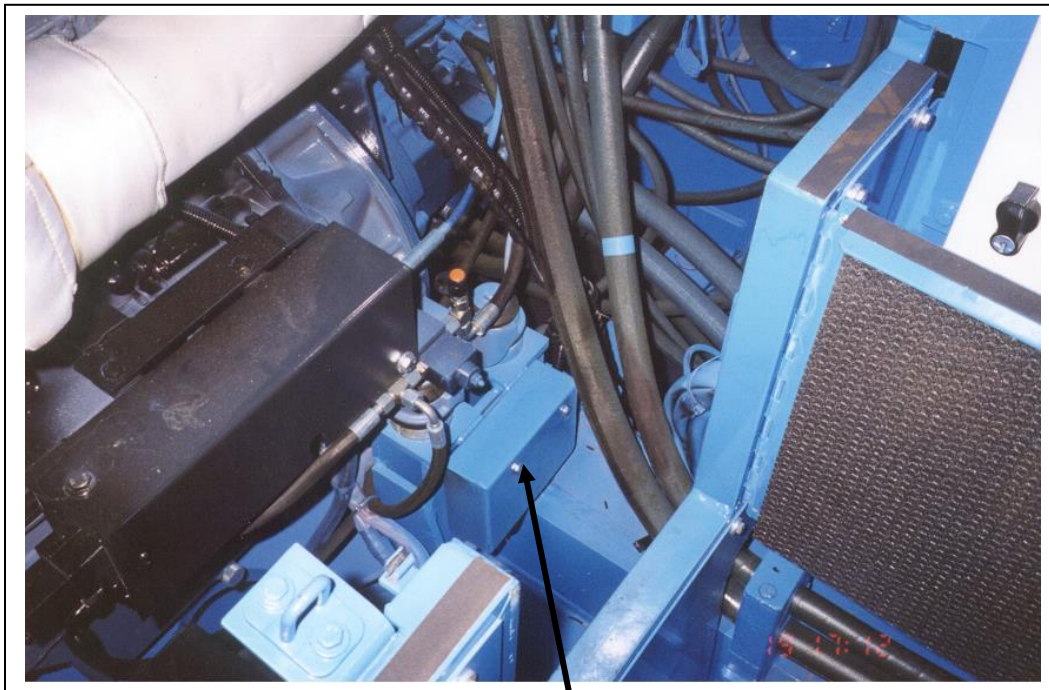

Power distribution box

(picture shows 360, similar for 350)

10. Remove the cover from the power distribution box and mount the circuit breaker and relay on the back plate of the box. Draw 24 volt power off the main power terminal in the box and wire to the breaker using 12 gauge red wire. From the breaker run the 12 gauge red wire to the relays main power in terminal #(30). From the outlet of the

relay there must be two wires, a 12 gauge red (from the condenser) and an inline ATO fuse holder. Both wires can be crimped into one yellow female quick disconnect terminal. Connect the second black wire from the wire bundle to the other end of the ATO fuse holder. The control power for the relay comes from the red 14 gauge wire running from the A/C on /off switch in the cab. Connect this wire to either relay control terminals on the relay #(85) (86) and connect the other terminal to ground. Install a 5 amp ATO fuse in the fuse holder to protect the compressor clutch circuit.

11. Test the electrical system before closing up any boxes or panels. Check the rotation of the condenser fans to ensure they are pulling air through the box. Check that there is power to the binary switch at the compressor. ****NOTE**** The compressor clutch will not engage until there is sufficient pressure in the system******

ELECTRICAL:

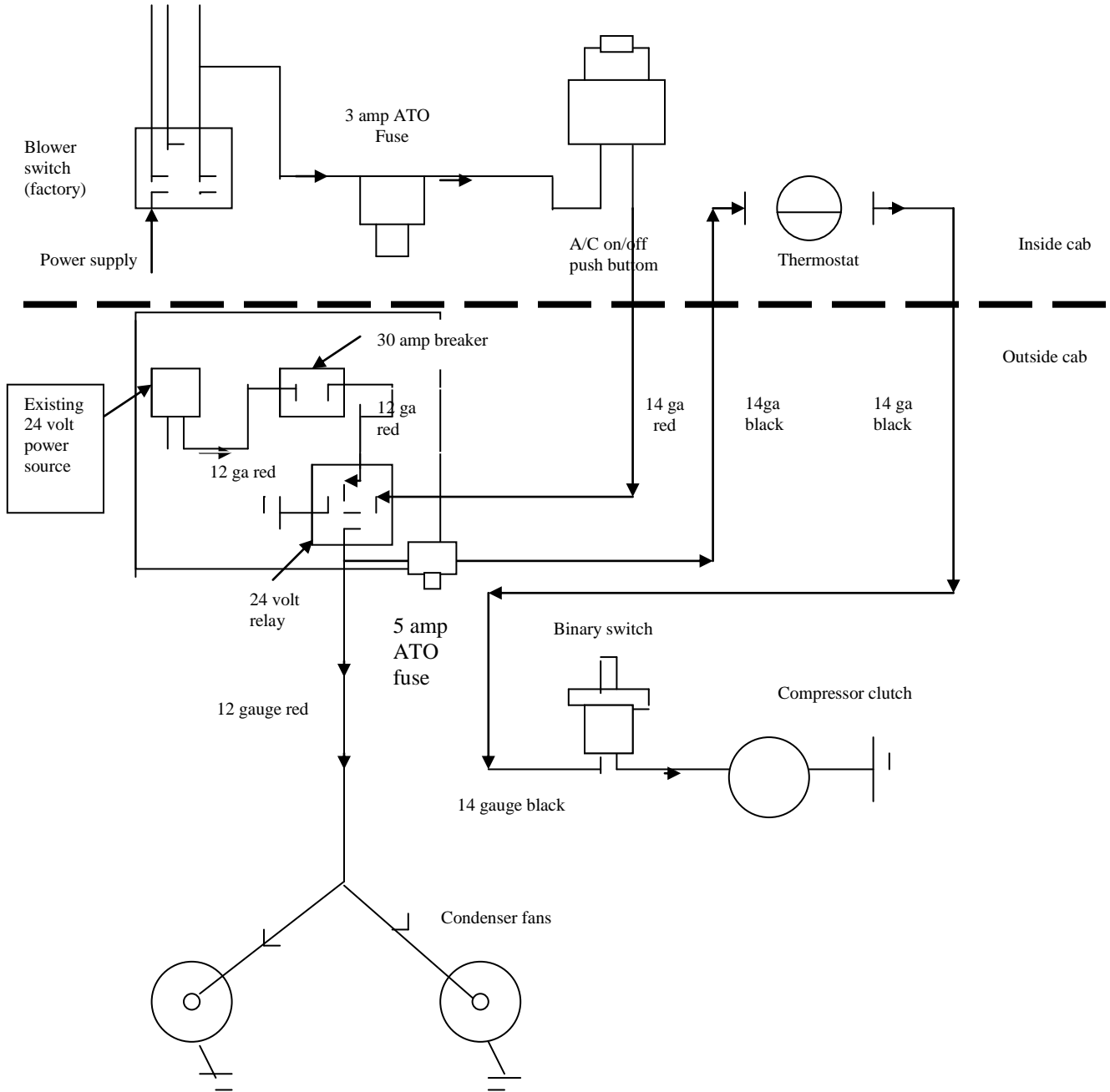

Final checks and charging:

1. Pressure test the system with nitrogen to at least 250 PSI and check all fitting and connections for leaks. The complete electrical system can be tested while there is pressure in the system as well.
2. Vacuum the system out with a good vacuum pump for ½ hour to 45 minutes. Ensure the system holds a vacuum to double check it for leaks. Add 4 oz of PAG oil to the system. Charge the system with 3 lbs of new 134A refrigerant. Run the system to test it. Check the temperature at the louvers. Add 134A refrigerant in 2 oz increments and check the air temp. A charge of 3 lbs 8 oz should be about right.
3. Check that the thermostat is cycling the compressor off before coil freeze up problems can occur. The thermostat can be adjusted with the adjustment screw under the plastic cap on the body of the thermostat. See the thermostat setting procedures at the end of this instruction manual.

Refrigerant Flow Pattern in a Standard Air Conditioning System

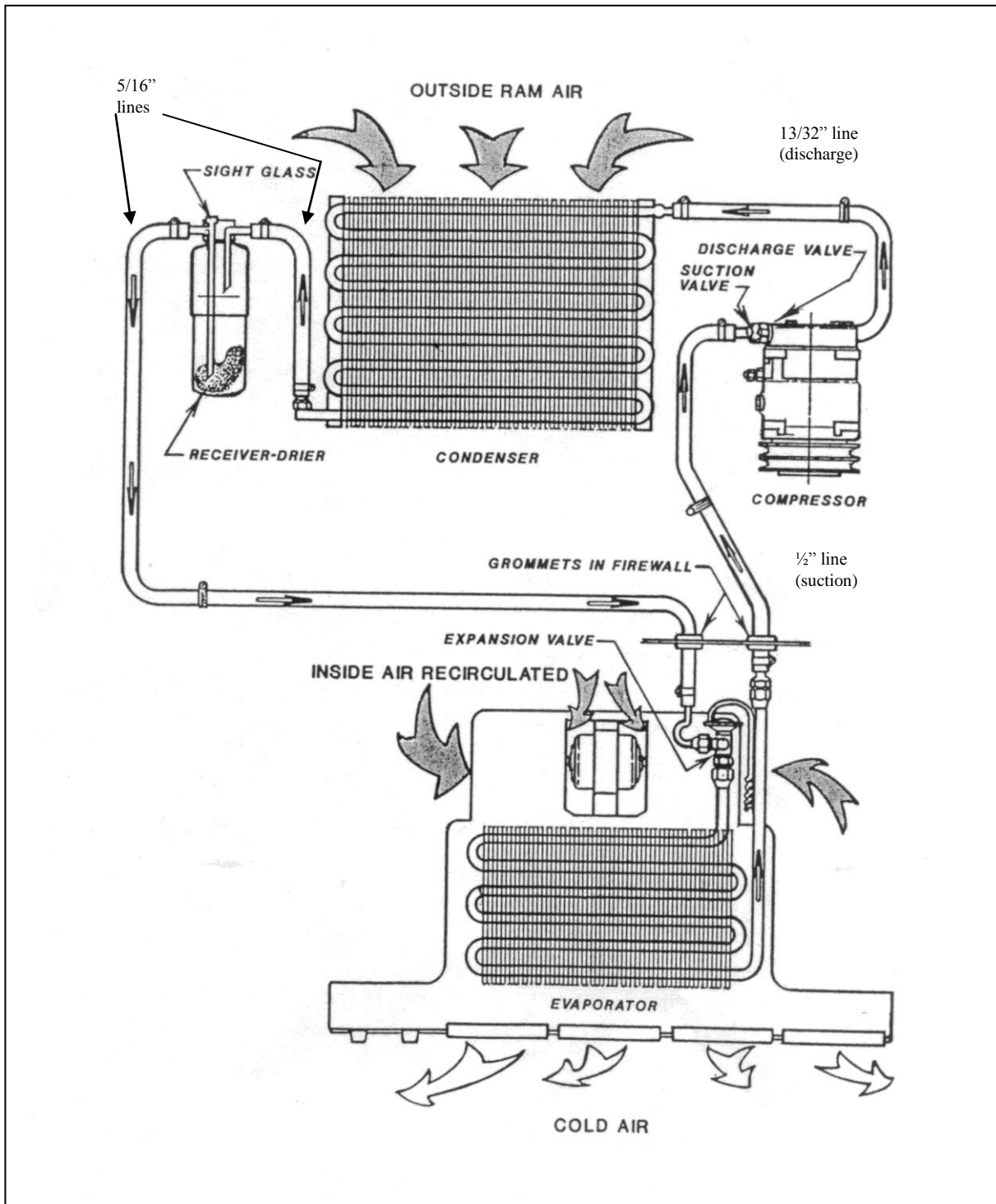

Thermostat Setting Procedures

- 1) Thermostat types
 - a) preset
 - b) adjustable
 - a) A preset thermostat is adjusted to its specific cut in and cut out temperatures when manufactured and does not have a rotary adjustment for the operator.
 - b) An adjustable or rotary thermostat has been manufactured to a predetermined cut in and cut out temperatures, but it is also operator adjustable to achieve the desired comfort level.

Both types of thermostats can have their factory settings adjusted by turning the setting screws on the body of the thermostat. One body type has the setting screws mounted externally and labeled for direction of rotation. The other body type requires the removal of the plastic end plate to expose the set screw.

- 2) Thermostat probe location: The location of the thermostat probe in an evaporator coil can be very important to achieve the maximum cooling potential of the coil while also preventing coil freeze-up. There is no set location for the thermostat probe to be put that will be optimum for all systems, but several rules of thumb may be followed:
 - a) Insert the probe in the coldest area of the evaporator coil.
 - b) Insert the probe from the top of the coil down, if possible.
 - c) Make sure that at least the last 3" of the thermostat probe are in the coil.

To find the most likely area where the coil is the coldest, consider these factors:

- 1) Direction of air flow through the coil.
 - 2) The coil area likely to have the lowest air flow.
 - 3) The inlet locations of the refrigerant into the coil.
 - 4) The inlet of the hotter outside air into the coil area.
-
- 1) Usually the coldest side of the evaporator coil will be the air outlet side. Often the thermostat probe can be inserted between the last and second last row of tubes.
 - 2) The lower air flow area of the evaporator coil in most systems tends to be near either end of the coil. These areas will be colder
 - 3) The area of the coil that the refrigerant inlet tube(s) occupy should be the coldest part of the coil.
 - 4) If the system is equipped with an outside air intake, where and how that air is brought into the evaporator area can have a large effect on the coil temperature. If all the outside air is piped into the evaporator in one area, that area will be considerably warmer in hot weather.

By looking at all these different factors, the area of an evaporator coil most likely to be the coldest can be determined.

Once the probe is inserted, the A/C system needs to be tested. Run the system to ensure that the thermostat is cycling the compressor off at the appropriate temperature. A core temperature ranging between 25° and 30° F should cause the thermostat to cycle off. The air temperature at the vent outlet closest to the evaporator coil should be between 38° F and 45° F when the compressor cycles off.

If the thermostat doesn't cycle off after a reasonable cool down period, and the air outlet temperature has dropped below 40° F, the cut in and cut out settings should be adjusted until the compressor is cycling on and off regularly. Let the system run for a decent time period (at least 15 min) and then check the evaporator coil for any signs of freezing.

Aeroquip E-Z Clip Assembly Instructions

Step 1. Cut the hose to proper length with an appropriate cutting tool. Aeroquip's hand held hose cutter has been specially designed for cutting all non-wire reinforced hose, such as GH-134 Multi-Refrigerant hose. Be sure the cut is made square to the hose length.

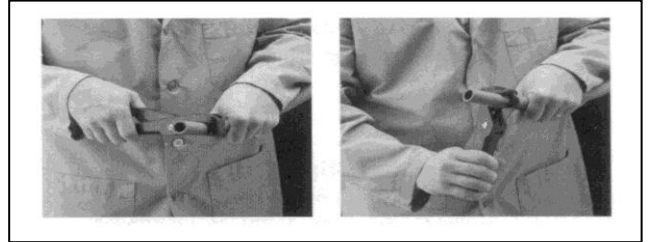

Step 2. Install two proper-sized clips onto the cut end of the hose. Orientation of the clips does not affect the performance of the connection. However, for ease of assembly, both clips should have the same orientation. NOTE: Failure to slide the clips over the hose at this time will require the clips to be stretched over the hose or fitting later. This may permanently damage the clip.

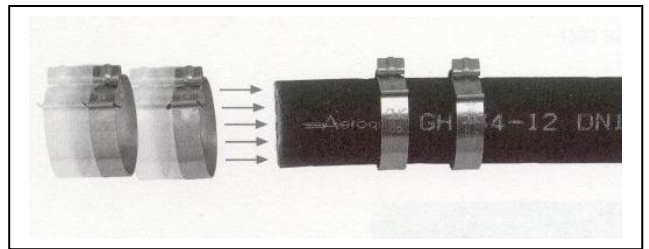

Step 3. Lubricate the nipple with a generous amount of the refrigeration or A/C system's compressor lubricating oil. This MUST be done to lower the force of nipple insertion.

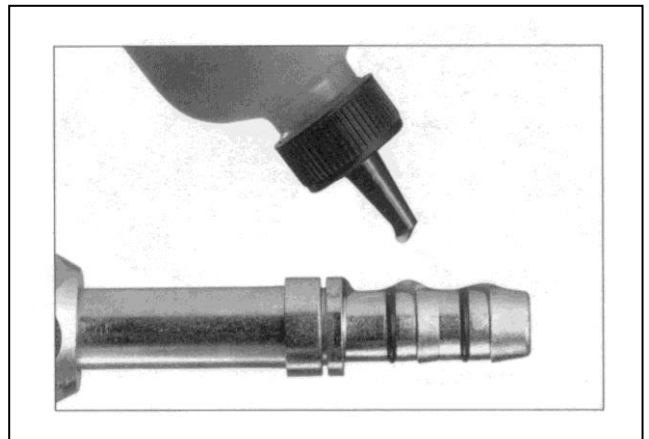

Step 4. Insert the nipple into the hose. To ensure that the nipple is fully inserted, check the gap between the cut end of the hose and the shoulder on the nipple. Care should be taken to avoid kinking or other damage to the hose during nipple insertion. NOTE: Be sure to wipe excess oil from the nipple and hose.



Step 5. Snap the cage into the groove on the nipple. The arms should extend over the hose length. When the cage has been correctly installed in the cage groove, the cage will be able to rotate in the groove. This step **MUST** be performed to ensure:

1. The clips will be located over the O-rings on the nipple.
2. The connection will be compatible with the connection's pressure rating.

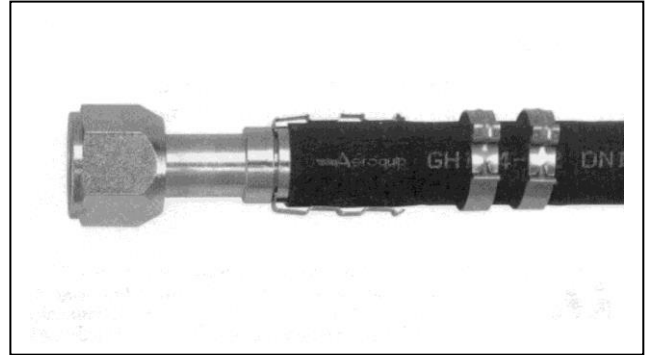

Step 6. Slide the clips over the cage arms and into the channels on each arm.

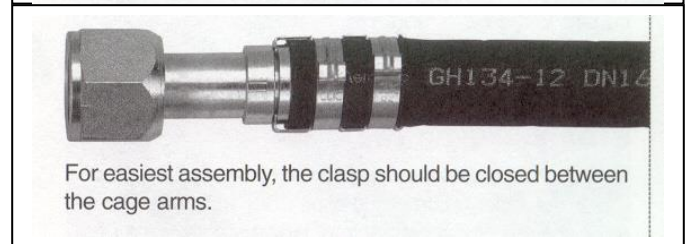

Step 7. Use the pliers to close the clips. The pliers should be positioned squarely on the clip connection points and should remain square during the closing of the clip.

NOTICE: E-Z Clip components should not be reused.

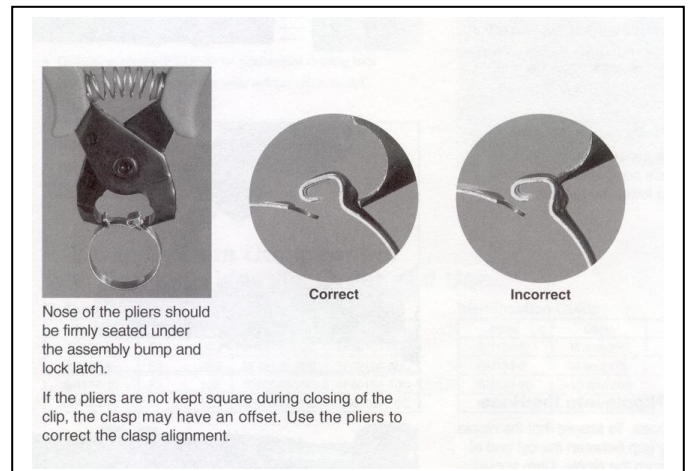
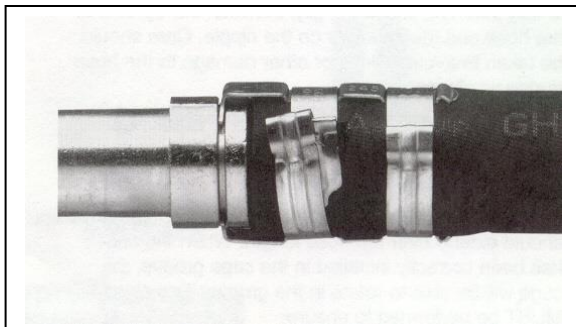

SERVICE BULLETIN FOR ALL FUCHS MHL MACHINES WITH NEW CABS

SUBJECT : CAB AIR FILTER SERVICING

The heat/ac pressurizer systems in the newer Fuchs cabs, on all sizes of machines, have an air filter in the cab that must be serviced regularly. The filter is a washable foam type of media mounted in a removable metal frame. **(The location of this filter is not visible from inside or outside the cab)** and must have an access panel, in the cab, removed to access it. If an operator is complaining about a lack of airflow from the heater/ac systems, a plugged filter is likely the problem.

Service procedures:

- 1) Pull the operators seat forward and tip the seat back all the way down. This will give access to the filter service panel located directly behind the operators seat and ahead of the inside air intake vents. Remove the seven philps screws holding the filter service panel in place and then remove the panel.

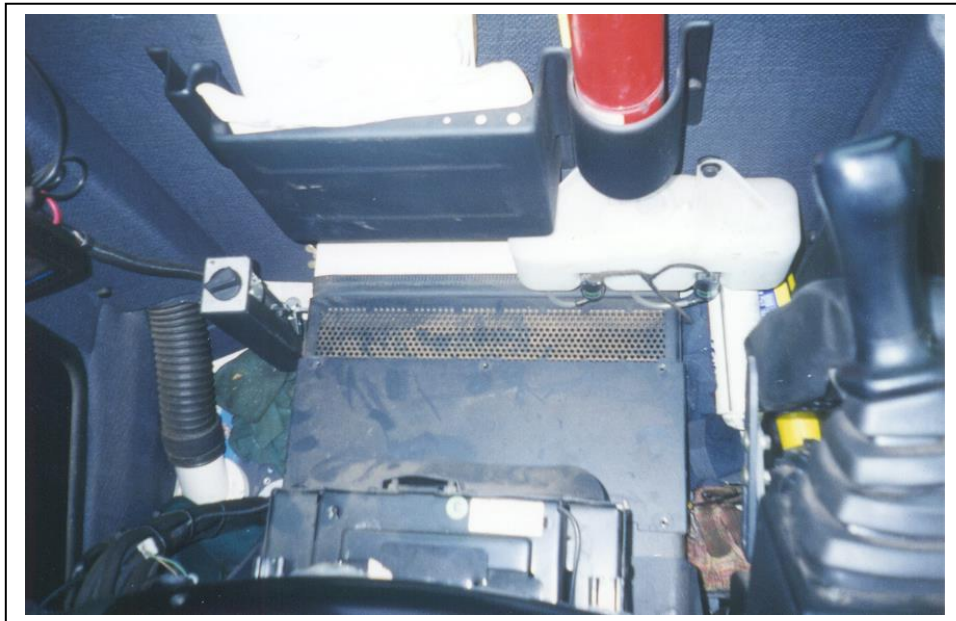

- 2) Remove the filter and metal frame from the blower box by pulling the metal frame straight up. Check the back of the filter for dirt buildup that would cause reduced airflow.



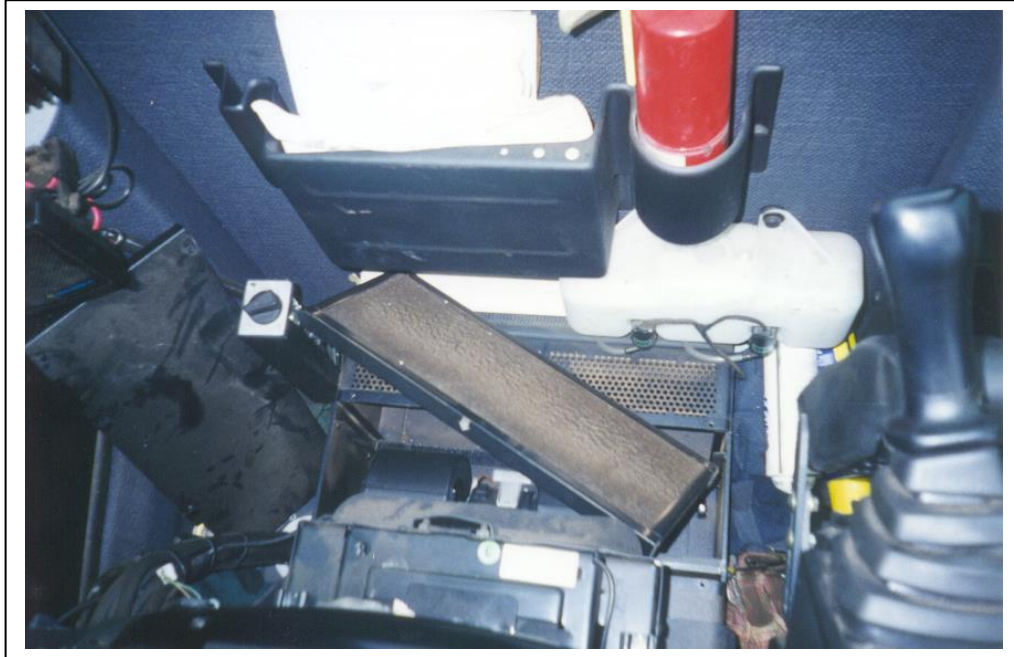

- 3) If the filter is dirty, remove it from its metal frame and wash it out with warm water. Shake it dry and re-install it back into the metal filter frame. Slide the metal frame back into the blower box. Take care to locate the air flow direction arrow at the top of the box pointing towards the blowers. Re-install the access panel and seven philps screws.

The frequency of the service will be determined by the environment a particular machine is working in. The badly plugged filter shown here was in a machine with 600 hrs on it.

For replacement filter media please contact your local Fuchs parts supplier.